

F50
RAILING SYSTEM

Barandilla Aluminio Anodizado
Anodized Aluminium Railings





Aluminco, comenzó su andadura en el año 1982 con la expectativa de llegar al mercado con productos innovadores, de diseños vanguardistas y con sistemas de barandillas y escaleras creados en exclusiva, que daban a un producto tradicional como la fundición de aluminio, el prestigio e interés que necesitaba.

Actualmente, todo a evolucionado con productos de aluminio de última generación y Aluminco sigue mostrando su liderazgo y prestigio no solo por la calidad de sus productos, también por la calidad de todos sus procesos que en ella se llevan a cabo.

En nuestros días, esta desarrollando una industria del aluminio vertical, que procesa el aluminio en 3 fases:

- Extrusión: Con una capacidad de producción de 13.000 toneladas de perfil por año.
- Puertas & Paneles: Con una capacidad de producción de 70.000 paneles por año.
- Fundición: Con una capacidad de producción de 13.000 toneladas de perfil por año.

*Aluminco ofrece una amplia gama de productos en los que destacamos:.

- Perfiles de aluminio.
- Paneles de aluminio
- Puertas de entrada principal
- Sistema de barandillas y escaleras
- Farolas y muebles de jardín.

Con espíritu inquieto e innovador, continuamente se centra en la investigación y el desarrollo de nuevos productos y sistemas los cuáles cumplen completamente la calidad, estética y estándares de funcionalidad.

La calidad es un máximo referente en nuestra empresa y por ello certificamos nuestros trabajos:

- Con procesos de producción certificada por la norma ISO 9001 & ISO9014 y procesos específicos de pintura bajo el sello de calidad QUALICOAT.
- Certificados por el instituto internacional y organizaciones como: IFT Rosenheim, Bureau Veritas, TUV, INSTITUTO GIORDANO, ICC, EKANAL.

Realizamos múltiples soluciones y productos de forma personalizada, que cumplen con los requisitos de los clientes más exigentes.







INDEX / ÍNDICE

Anodizado / Anodizing	10	Horizon H-RINGS	54
Instalación regular / Installation regulations	12	Horizon FRAME	56
Accord	16	Horizon BLADE	58
Accord QUATTRO	24	Vertical	60
Accord SQUARE	26	Vertical-R	62
Accord XSQUARE	28	Vertical-D	64
Accord SQUAREQ	30	Vertical-Q	66
Accord TUBULAR	32	Slim Line	68
Accord BLADE	36	Classic European	71
Horizon	38	Perfiles/ Profiles	76
Horizon X-RAIL	40	Accesorios / Accessories	80
Horizon SQUARE X-RAIL	44		
Horizon QUATTRO	46	F50 profile calibrator in metric system	100
Horizon MAX	48	Montaje de materiales/ Montage Materials	102
Horizon U-RAIL	50	Notas / Notes	105

F50



Aluminco presenta:

ALUMINCO presents its modern, stylish and fully integrated railing system. The F50 Railing System.

Su linea elegante F50 Railing System, basada en un diseño simple y elegante.

El sistema tubular anodizado esta elaborado con soportes creativos y distintivos con un alta estética, estos elementos crean una armonía que junto la belleza, elegancia hacen de ello una mirada inspiradora.

Ofrece opciones ilimitadas para aplicarlas a numerosas soluciones arquitectónicas.

La serie tipo INOX, tanto los perfiles como los accesorios se han realizado bajo un tratamiento anodizado, producido con un espesor de 20 micras que le hacen estremadamente fuerte y a la vez inoxidable.

F50 Railing System is based on an extremely simple design and constructional concept: a tubular system of anodized or polyester powder coated aluminum, which is elaborately bonded with connectors and supports creating a discrete, distinctive and high aesthetics result.

Its metal elements fit in harmony together forming an extremely elegant, beautiful, and inspiring look. They can optionally be combined with a variety of Lexan® polycarbonate sheets or glass, offering unlimited options for numerous architectural applications.

In INOX type series, aluminum profiles and accessories have gone under an advanced anodizing treatment, characterized by unique properties: extreme hardness - second only to diamond - and unique stainless steel finish. The series offers substantial competitive advantages over stainless steel systems: high aesthetics, lightweight and lower cost.



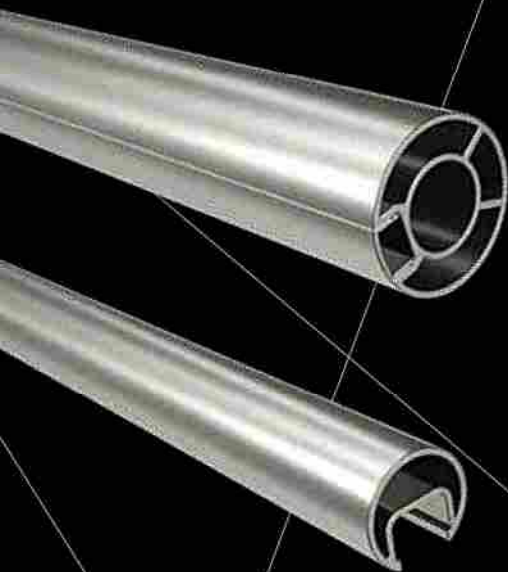

BENEFICIOS DEL ANODIZADO:

El anodizado es un acabado único que cumple con altos estándares de calidad y tiene las siguientes ventajas:

- Gran resistencia: Vida útil extremadamente larga y sin mantenimiento.
- Resistencia al calor: Altamente resistente a los rayos UV y a las grietas.
- Fácil mantenimiento: El sistema de barandilla puede ser fácilmente limpiado utilizando agua y jabón.
- Alta estética: Apariencia similar al Acero Inoxidable.
- Bajo coste: Tanto la instalación como el mantenimiento tiene costes más bajos que el Acero.
- Seguro y duradero: El anodizado es un proceso químico no tóxico y altamente resistente al calor.

Cuidado & Mantenimiento

Para la limpieza sólo será necesario agua y un jabón suave si fuera necesario.

No utilizar productos químicos que dañen el producto.

Con que frecuencia debería limpiarse?

La limpieza debería realizarse 1 vez al mes cada 6 meses, dependiendo de las condiciones atmosféricas que este expuesto el modelo de barandilla F-50.

Acabado de pintura:

La pintura de poliéster en polvo protege de la corrosión y ofrece una alta estética.

En **Aluminco** la introducción del certificado de calidad QUALICOAT asegura que:

- *Crea una unidad adecuada en la capa de pintura, aprobada en este proceso.
- *El certificado obliga a poner en práctica cualquier especificación para evolucionar tecnológicamente y saber como realizarlo.

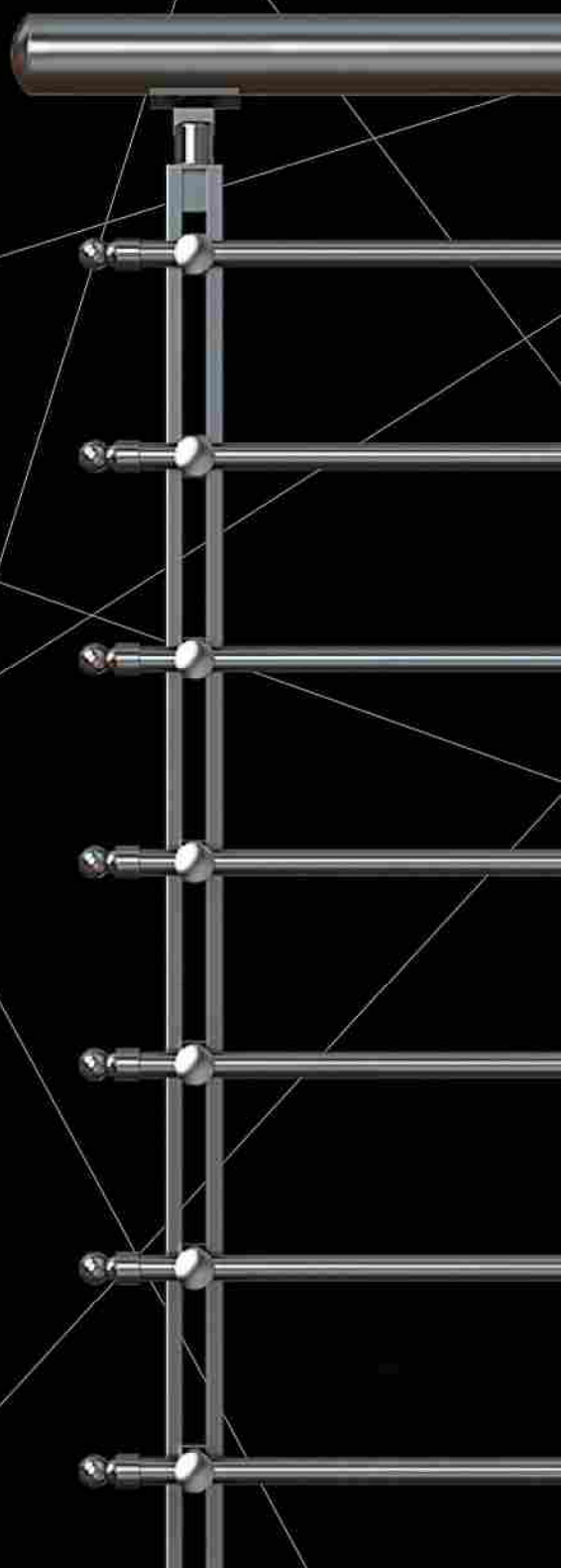

Accord

16

Lineas paralelas y simples montadas en total armonía.

Parallel lines and simple mounting in total accord.

Features



F50-300
Perfil Ø16x1.3
Profile Ø16x1.3



4314

Sujeción pasamanos a columna

Connector for handrail
Ø50 with column Ø42

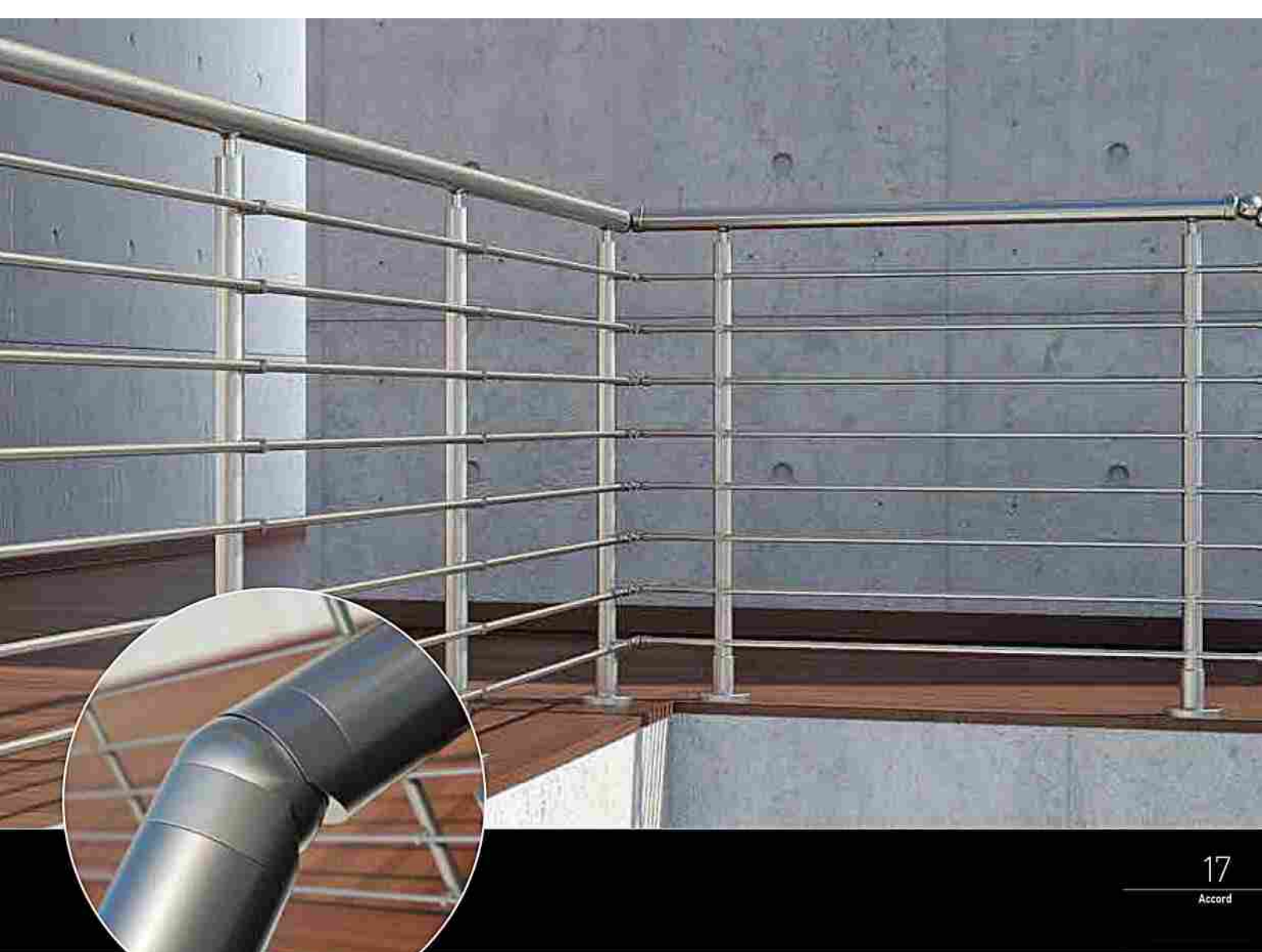

4329

Articulación esquina F50 pasamanos
Adjustable corner connector
for column Ø50



4112

Pie de sujeción de 12 cm para
columna
External support foot
for Ø42 column



4437

End cover for profile Ø16
Decoración final para escalera
F-16



4312

Unión columna F-50-100 para perfil F-16
Connector for F50-100
column with guide Ø16

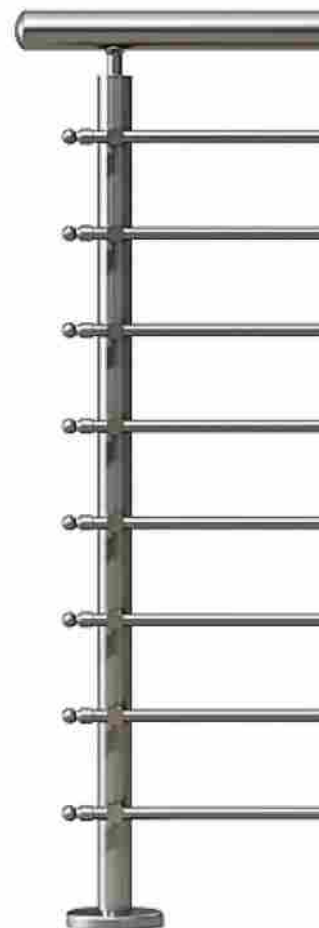



Accord

18

Accord



F50-300
 Perfil F-16 x 1,3mm
 Profile Ø16X1.3



4228

Connector 90° for profile Ø16
 Varilla conectora F-16 en 90°



4314

Sujeción pasamanos a columna

Connector for handrail
Ø50 with column Ø42



4219

Unión esquina pasamanos 90°

Connector 90°
for handrail Ø50



4229

Connector 135° for profile Ø16
Varilla conectora F-16 en 90°



4121

Support foot for Ø42 column
Pie de sujeción para columna
F 50-100

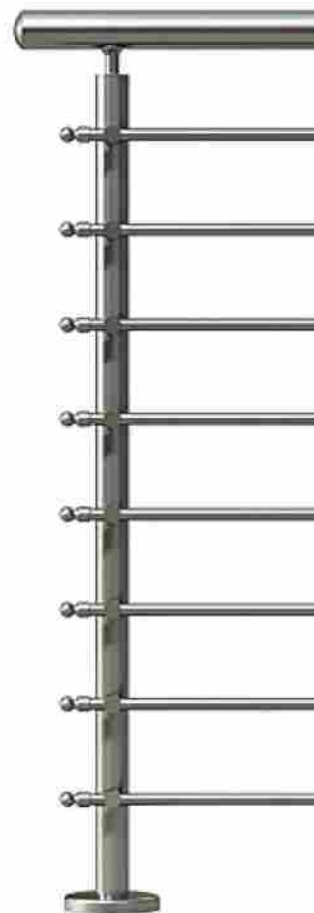

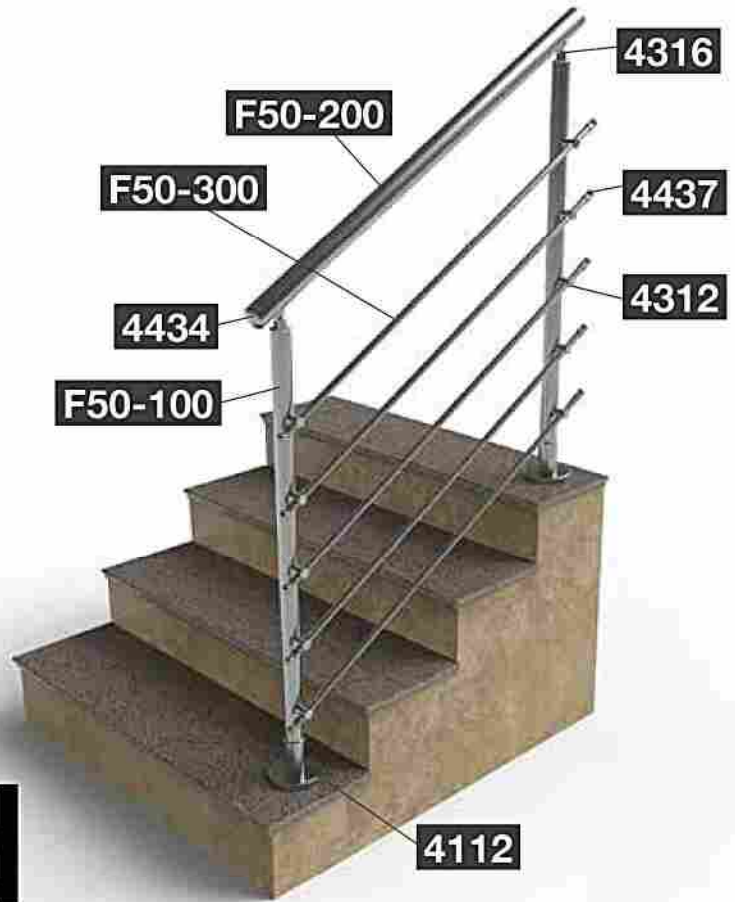

Accord

Specially designed accessories, allow application of the Accord design on any type of staircase, indoor or outdoor.



4316

Sujeción pasamanos a columna (escalera)
Connector for handrail Ø50 with column Ø42 (stairs)



4112

Pie de sujeción de 12 cm para columna
External support foot for Ø42 column



4437

Decoración final para escalera F-16
End cover for profile Ø16



4312

Unión columna F50-100 para perfil F-16
Connector for F50-100 column with guide Ø16



F50-100

Columna sujeción 42mm
Support column Ø42



F50-300

Perfil F-16 x 1,3 mm
Profile Ø16x1.3

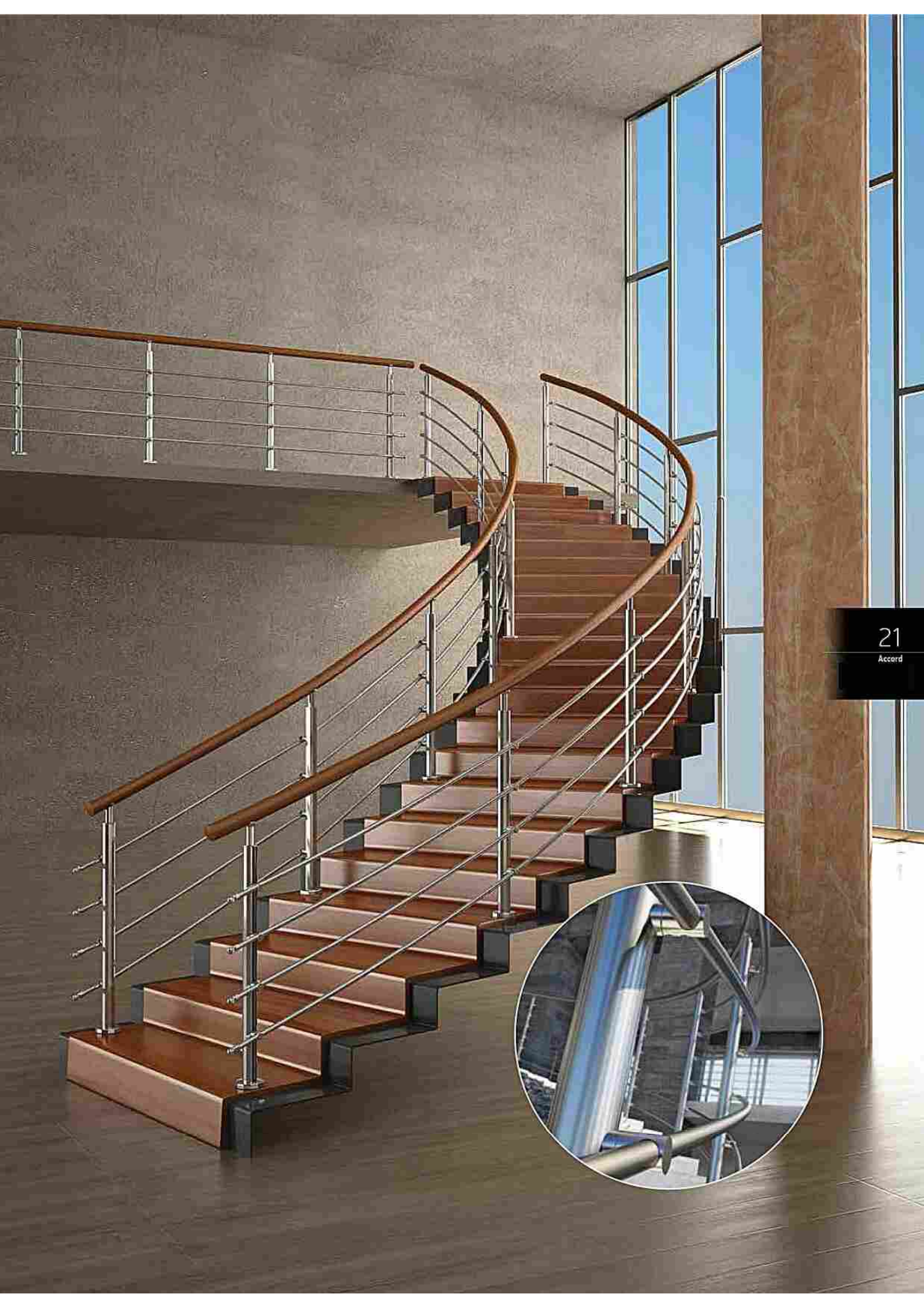



4116

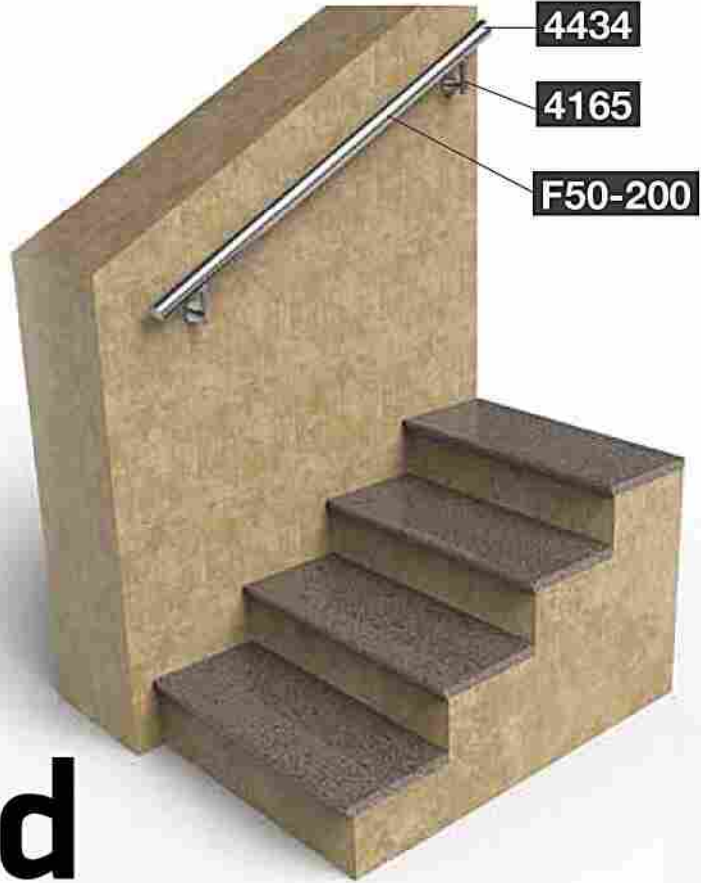

4434

4165

F50-200

Accord



4165

Unión pared a pasamanos F50-200

Wall support
for F50-200 handrail



4434

End cap for F50-200 handrail
Tapa pasamanos F50-200



4329

Articulación esquina F50
pasamanos

Adjustable corner
connector for column Ø50



4116

Support for F50-200 railtop
Soporte de 8,5 cm pasamanos a muro



F50-200

Handrail Ø50
Pasamanos F50 (50mm)





Accord QUATTRO

24

Accord QUATTRO

Armonía similar entre cuadrados y círculos.
Perfiles tubulares y rectangulares.

Harmonic assimilation between circle and
square. Tubular and rectangular profile.



4314

Sujeción pasamanos a columna

Connector for handrail
Ø50 with column Ø42



F50-302

Raíl cuadrado 16x16x2mm
Square 16x16x2



4509Z

Sujeción pasamanos a pared

Ø50 Railtop wall cover



4231

Unión pasamanos en 90°

Connector 90°
for handrail Ø50



4444

End cap for F50-302 profile

Tapa raíl F50-302



4232

Sujeción exterior de columna con F50-302

Connector for F50-100
Column with F50-302 profile

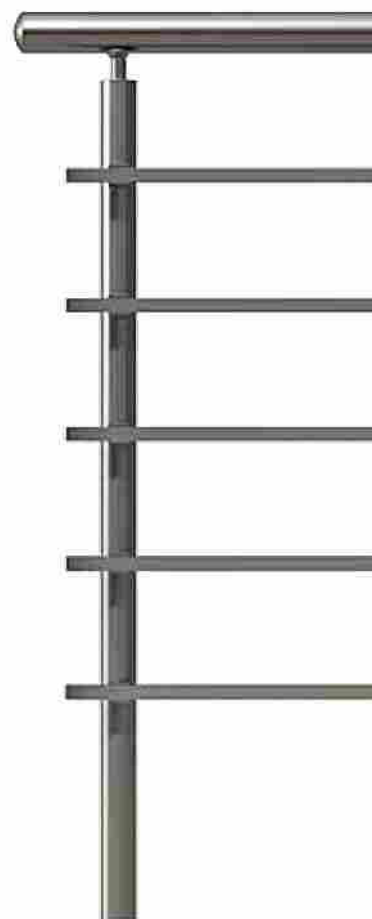

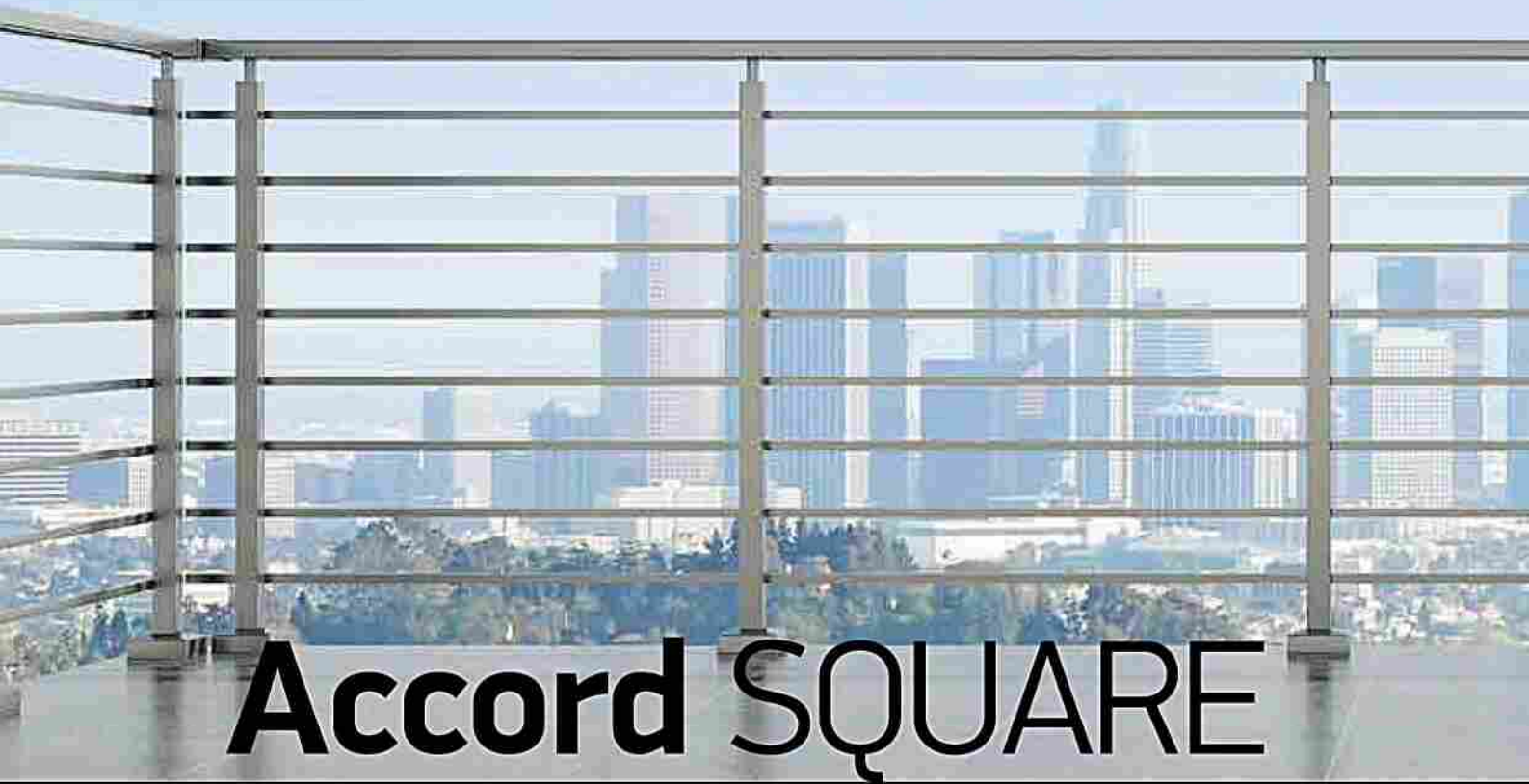

Accord SQUARE

26

Accord SQUARE

Basado en el concepto
Accord con perfiles y pasamanos
cuadrados

Based on the Accord concept,
with square profiles.

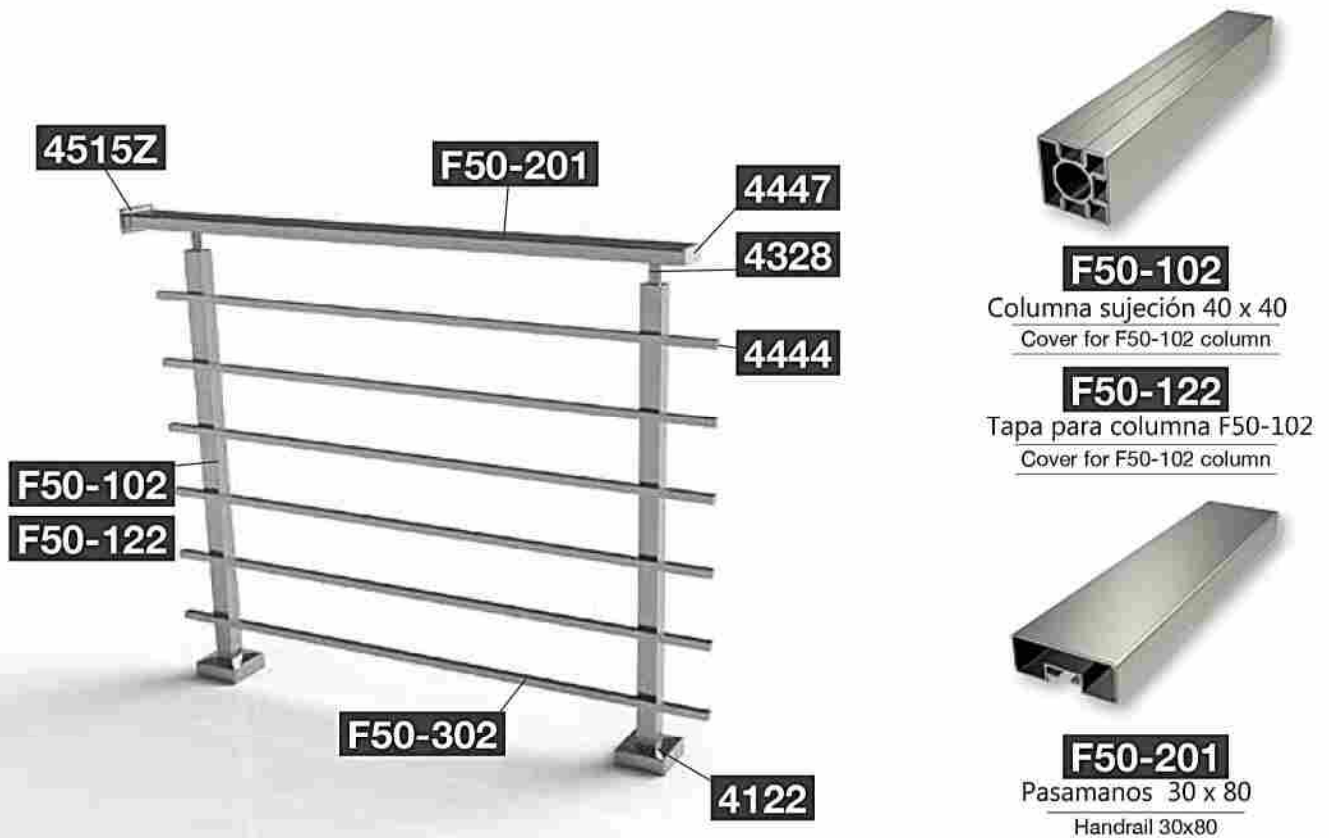



4328

Unión columna con pasamanos F-50-201

Support for F50-102 column
with F50-201 handrail



F50-302

Rail cuadrado 16x16x2
Square 16x16x2



4122

Support foot for 40x40 column
Pie para F50-102 y F50-106



4447

End cap for F50-201 handrail
Tapa para pasamanos
F50-201

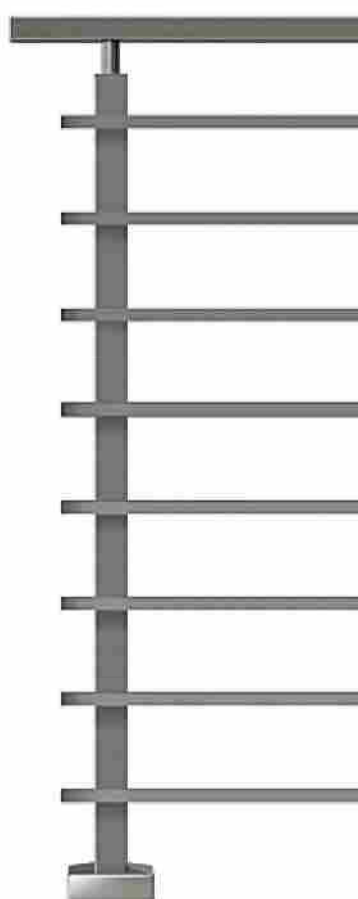



Accord XSQUARE

28

Accord XSQUARE

Accord Square es un tipo de barandilla discreto con conectores modernos.

Cubic notion of Accord Square, with discrete, modern connections.

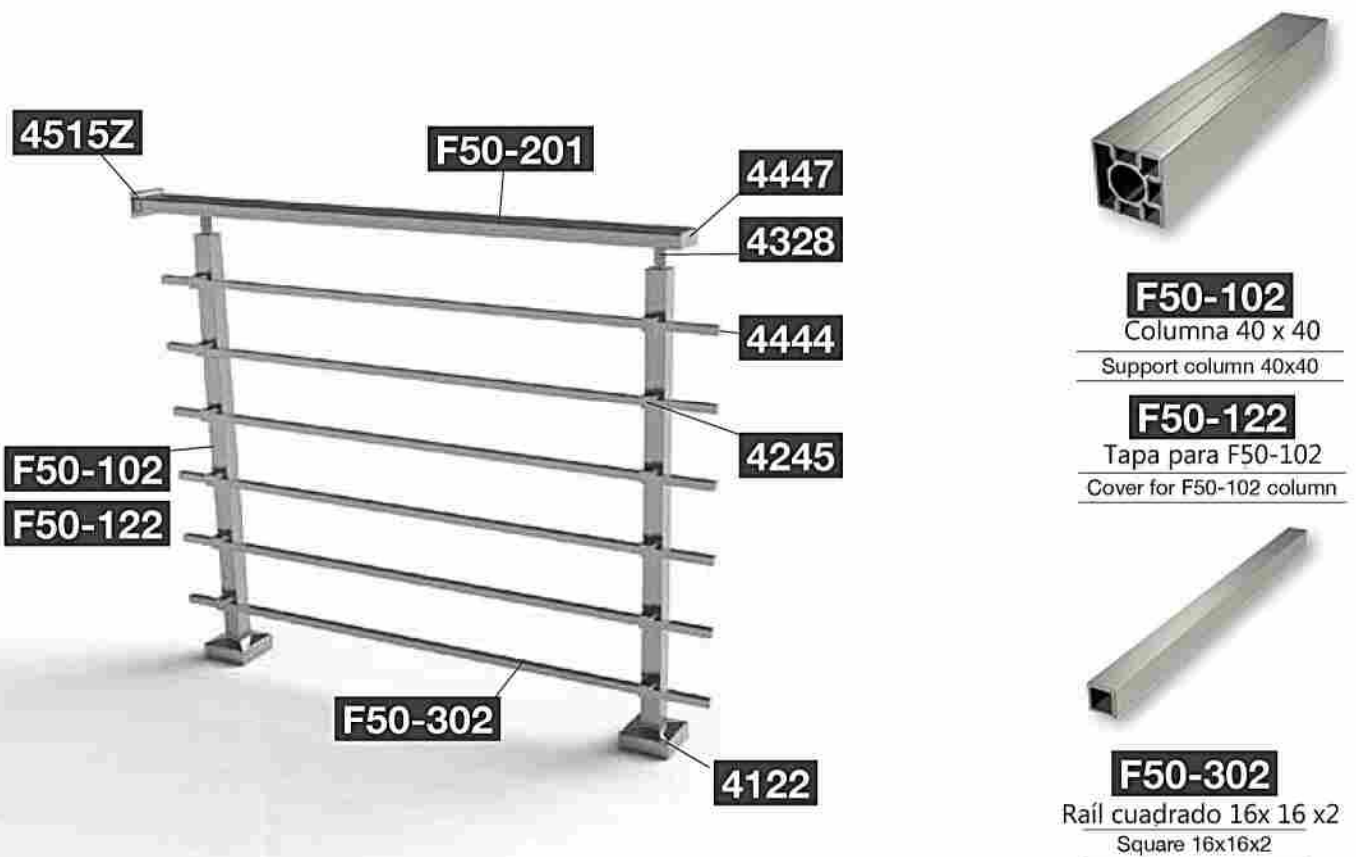

**4444**

Tapa rail F50-302(16x16)
End cap for F50-302 profile

**4245**

Unión exterior de F50-102/106 y F50-302

Connector for F50-102/106
Column with F50-302 profile

**4447**

Tapa pasamanos F50-201
End cap for F50-201 handrail

**4515Z**

Embellecedor para F50-201/203

Wall cover for F50-201/203
handrail (with cap)



Accord SQUAREQ

Perfecta combinación de perfiles cuadrados y tubos.
 Líneas simples en absoluta concordancia.
 Combinación de columnas y pasamanos cuadrados
 horizontales con perfiles de 16 y 26 de diámetro.

Perfect combination of square and tube profiles.
 Simple lines in absolute accordance.
 Combination square columns and railtop with
 horizontal tubular profiles Ø16 and Ø26.

30

Accord SQUAREQ

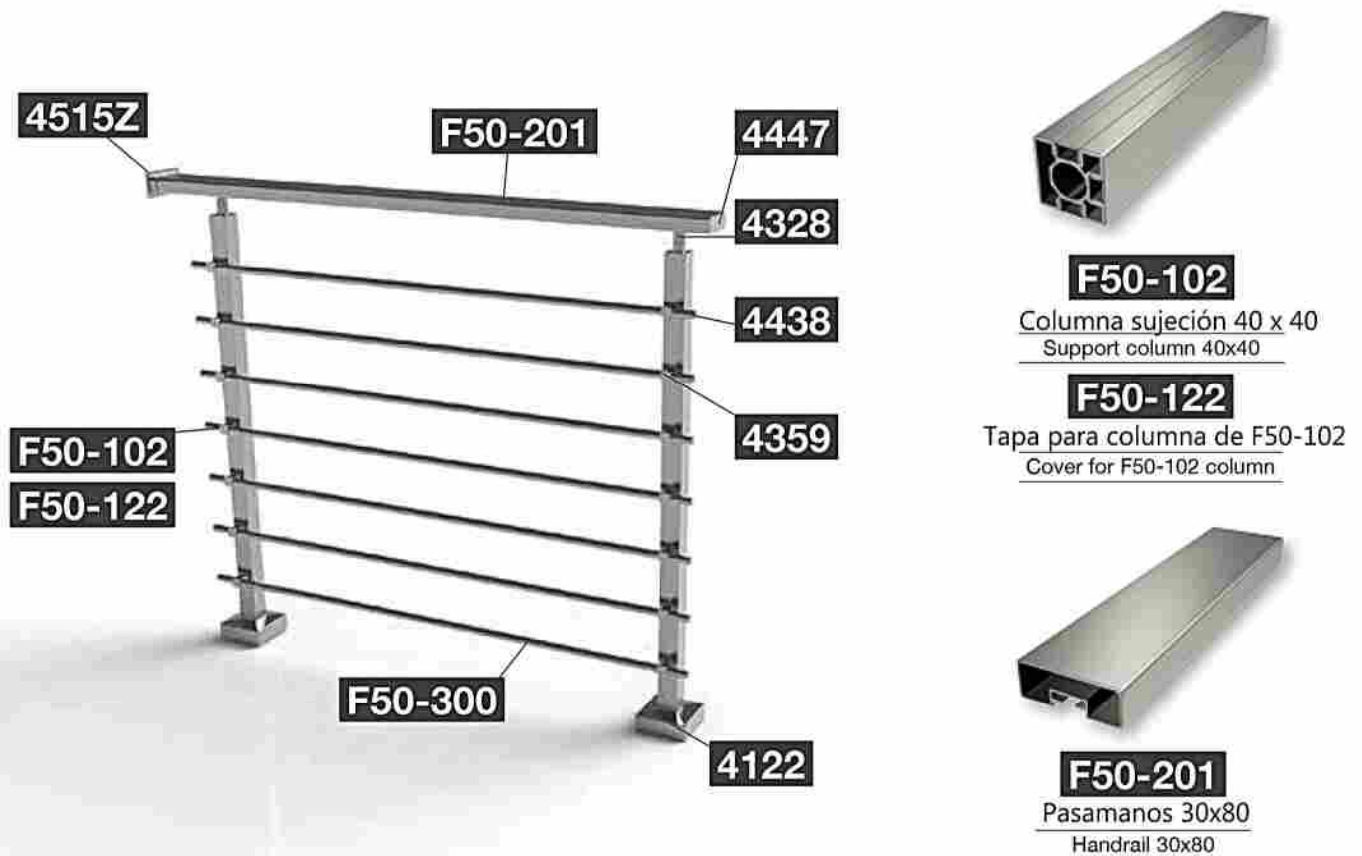

F50-102

Columna sujeción 40 x 40
 Support column 40x40

F50-122

Tapa para columna de F50-102
 Cover for F50-102 column



F50-201

Pasamanos 30x80
 Handrail 30x80

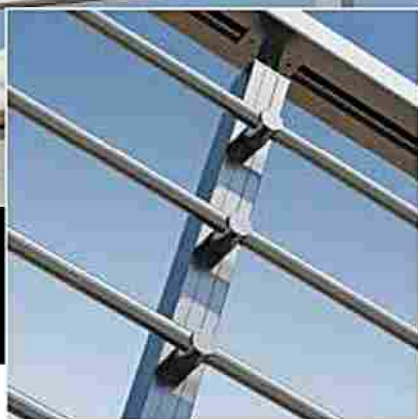

4328

Unión columna con pasamanos
F50-201
Support for F50-102 column
with F50-201 handrail



4122

Pie para F50-102 y F50-106
Support foot for 40x40 column



4358

Conector a columna F50-102
diámetro de 26
Connector for F50-102
column with profile Ø26



4359

Conector a columna F50-102
diámetro de 16
Connector for F50-102
column with profile Ø16

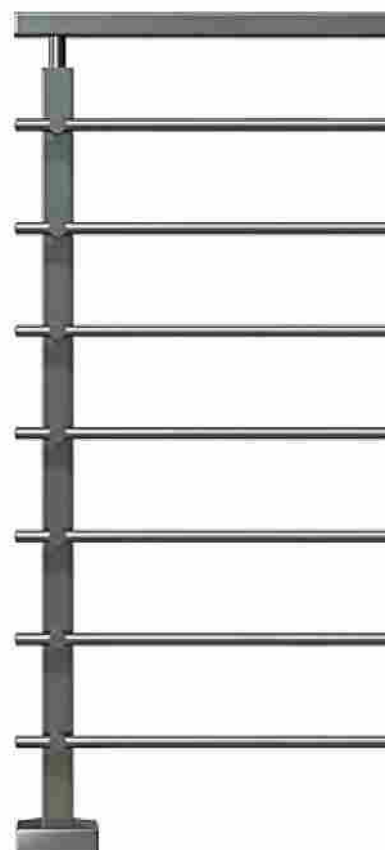



Accord TUBULAR

32

Accord TUBULAR

Perfecta combinación de perfiles y tubos cuadrados. Líneas simples absolutamente en concordancia.

Perfect combination of square and tube profiles. Simple lines in absolute accordance.

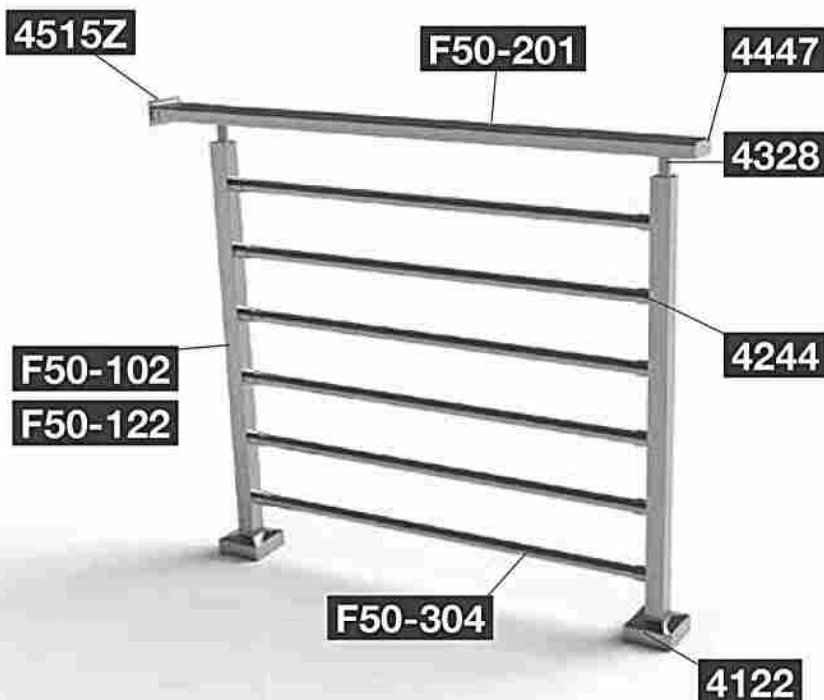

F50-102

Columna sujeción 40x40
Support column 40x40

F50-122

Tapa para columna F50-102
Cover for F50-102 column



F50-201

Pasamanos 30x80
Handrail 30x80



F50-304
 Perfil de 26mm
 Profile Ø26x1.8



4515Z
 Wall cover for F50-201/203
 handrail (with cap)



4328
 Unión columna con
 pasamanos F50-201
 Support for F50-102 column
 with F50-201 handrail



4244
 Unión externa del perfil
 F50-102/106 con F26
 Connector for F50-102/106
 Column with profile Ø26

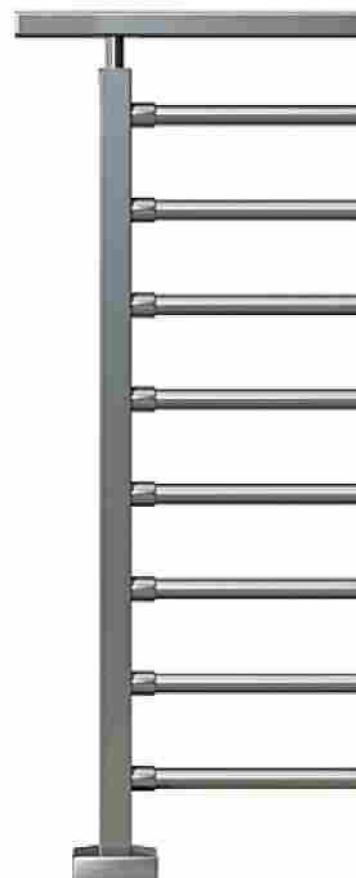

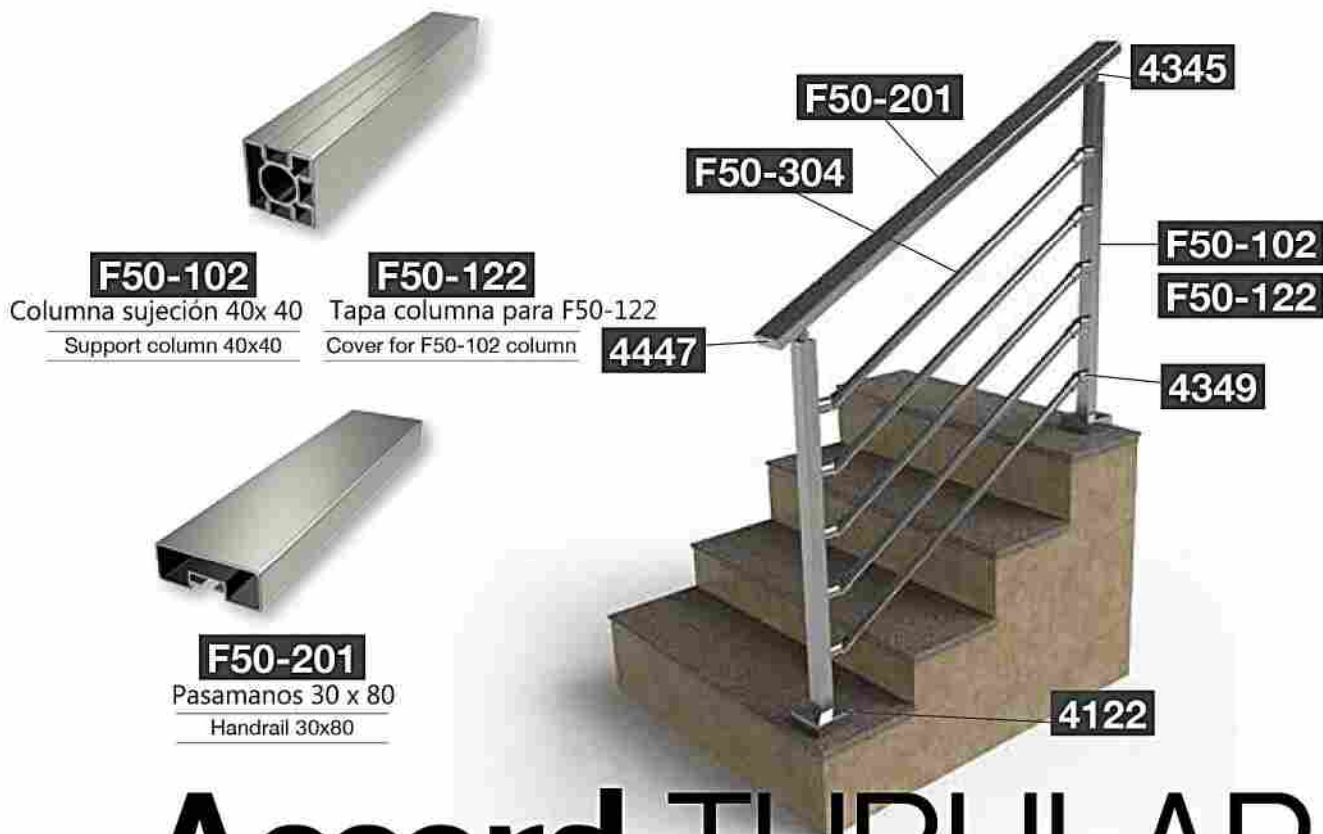

Accord TUBULAR



F50-304
 Perfil de 26mm
 Profile Ø26x1.8



4345
 Soporte para columna F50-102
 con pasamanos F50-201
 Connector for F50-102 column
 with F50-201 handrail



4349
 Unión de F50-102 con perfil
 de 26mm
 Connector for F50-102
 column with profile Ø26



4347
 Conector para pasamanos
 de 80 x 30
 Adjustable corner connector 90°
 for 80x30 handrail (stairs)



4447
 Tapa rail F50-319
 End cap for F50-201 handrail



4346
 Conector para pasamanos de 80 x 30
 Adjustable corner connector
 for 80x30 handrail (stairs)

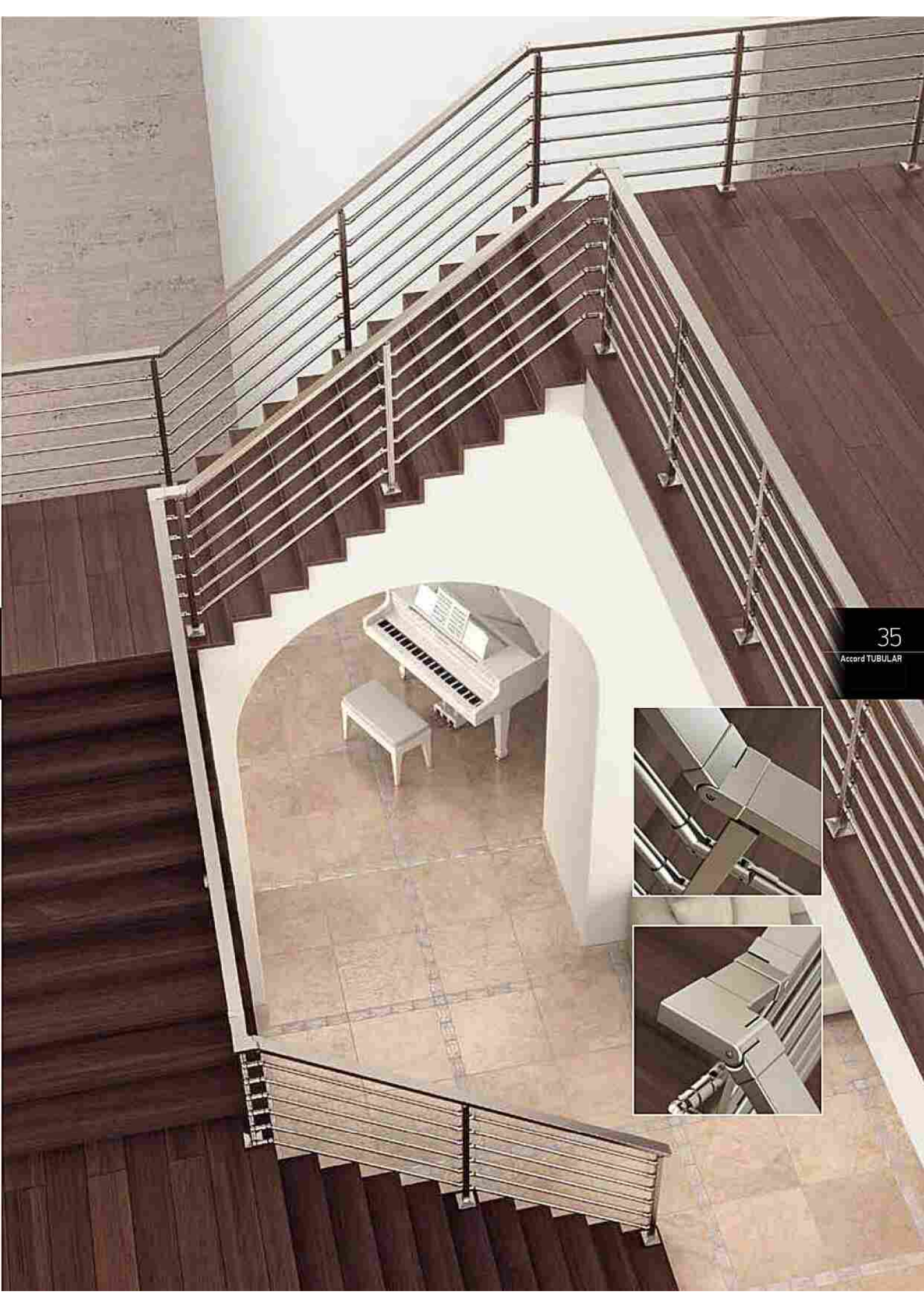



Accord BLADE

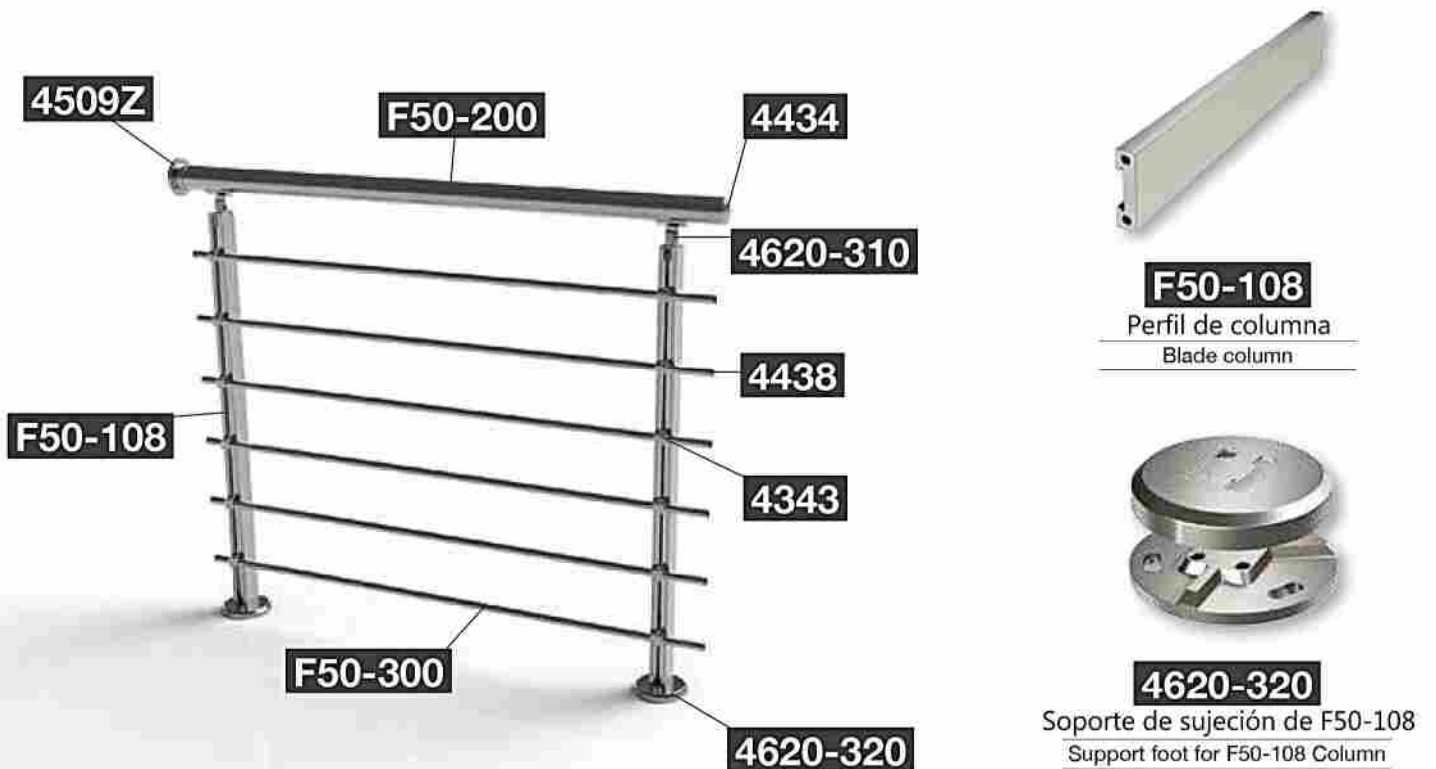

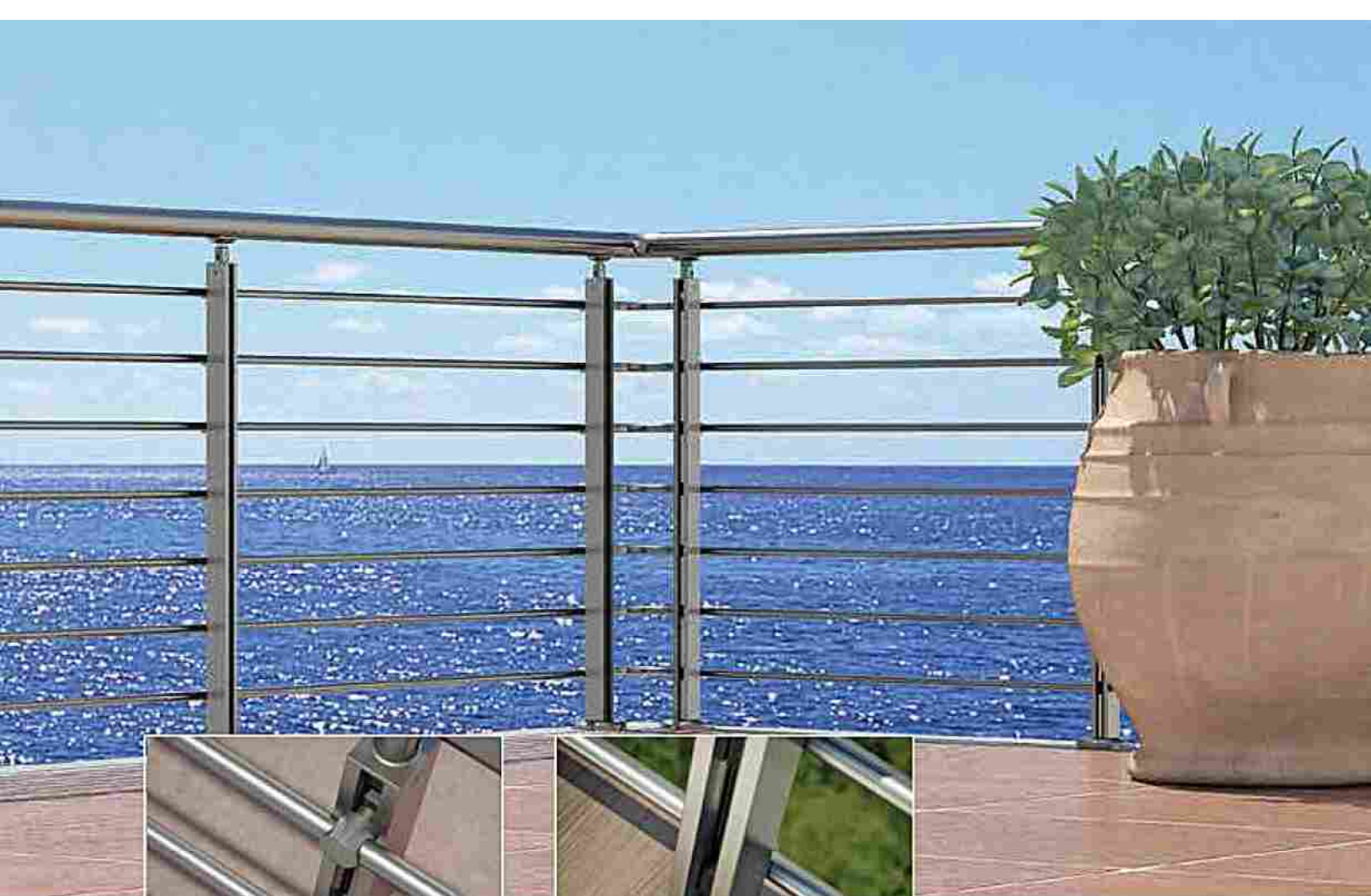

F50-300

Perfil F-16 x 1,3 mm de grosor
Profile Ø16X1,3



4620-310

Soporte de columna a pasamanos

Support for handrail Ø50 -
BLADE column



4437

Decoración final para escalera F-16
End cover for profile Ø16



4343

Unión de columna F50-102 con
pasamanos F50-201
Connector for profile
Ø16 with BLADE column

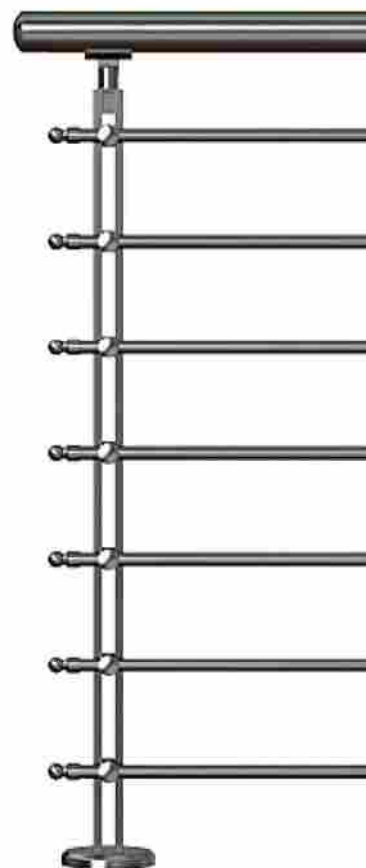



Horizon

38
Horizon

Visión panorámica con vista al horizonte. Pudiendo mirar al horizonte sin ningún tipo de obstáculo.

Delicate, ethereal and subtle. Relax at the magnificent view of the horizon. Let your imagination free and unobstructed.

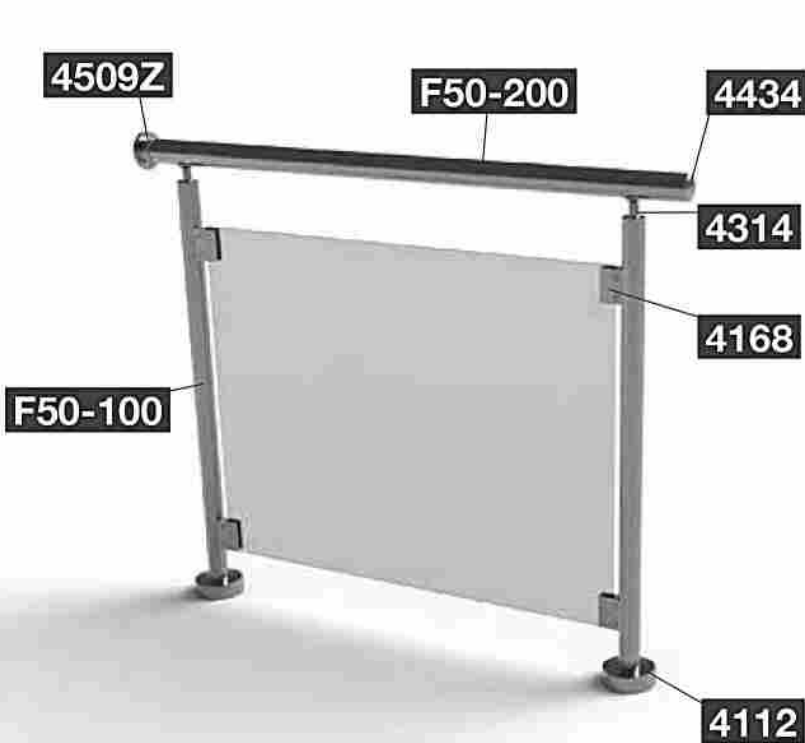

F50-200
Pasamanos F-50
Handrail Ø50



F50-100
Columna sujeción 42mm
Support column Ø42

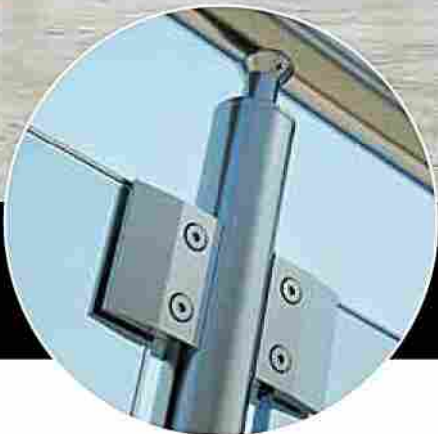

4168

Sujeción para cristal de 8 a 10mm
Glass support 8-10mm



4509Z

Sujeción de pasamanos a pared
Ø50 Railtop wall cover



4314

Sujeción de pasamanos a columna
Connector for handrail
Ø50 with column Ø42



4112

Pie de sujeción para columna F50-100
External support foot
for Ø42 column

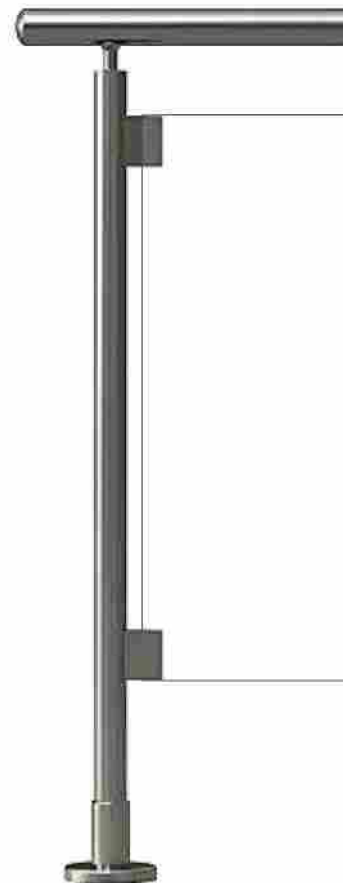

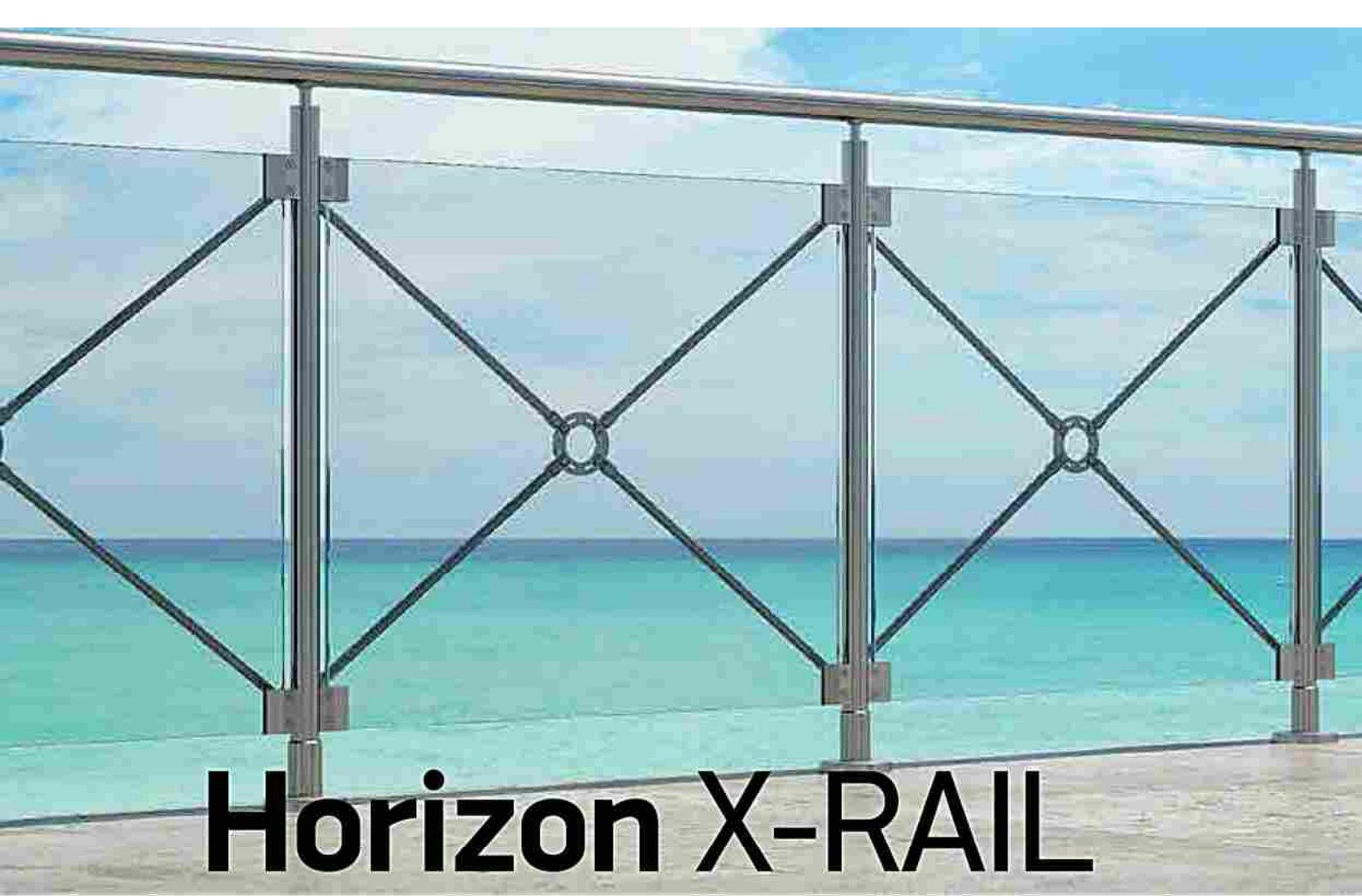

Horizon X-RAIL

40

Horizon X-RAIL

Prestigiosa belleza en creciente armonía.
En el cual se observa una visión panorámica.

Prestigious luxury. Beautifully
crafted mounting, targeting towards
the horizon. A real ornament.

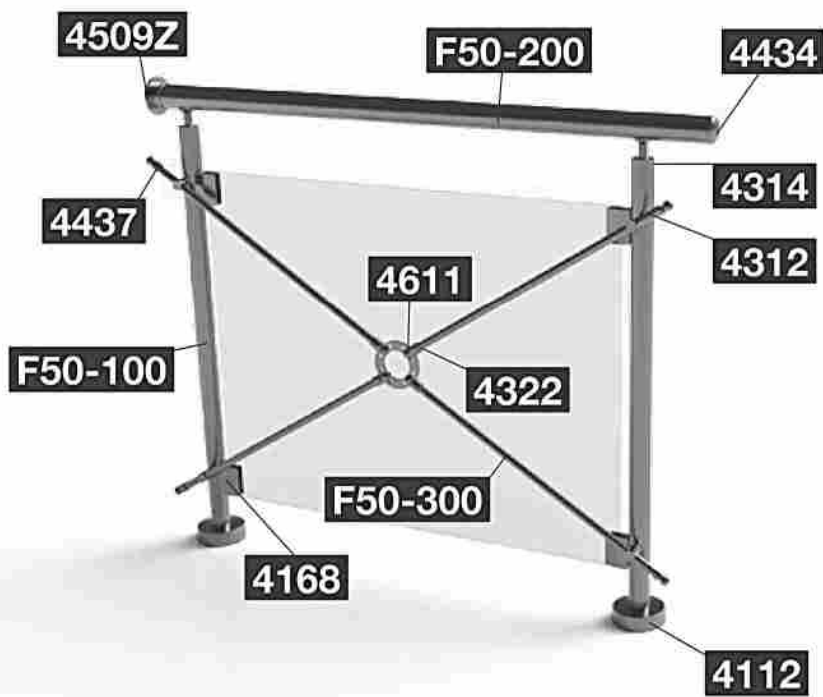

F50-300
Perfil F16 x 1,3 mm
Profile Ø16X1.3



4611
Roseta decorativa
Glass rosette Ø100

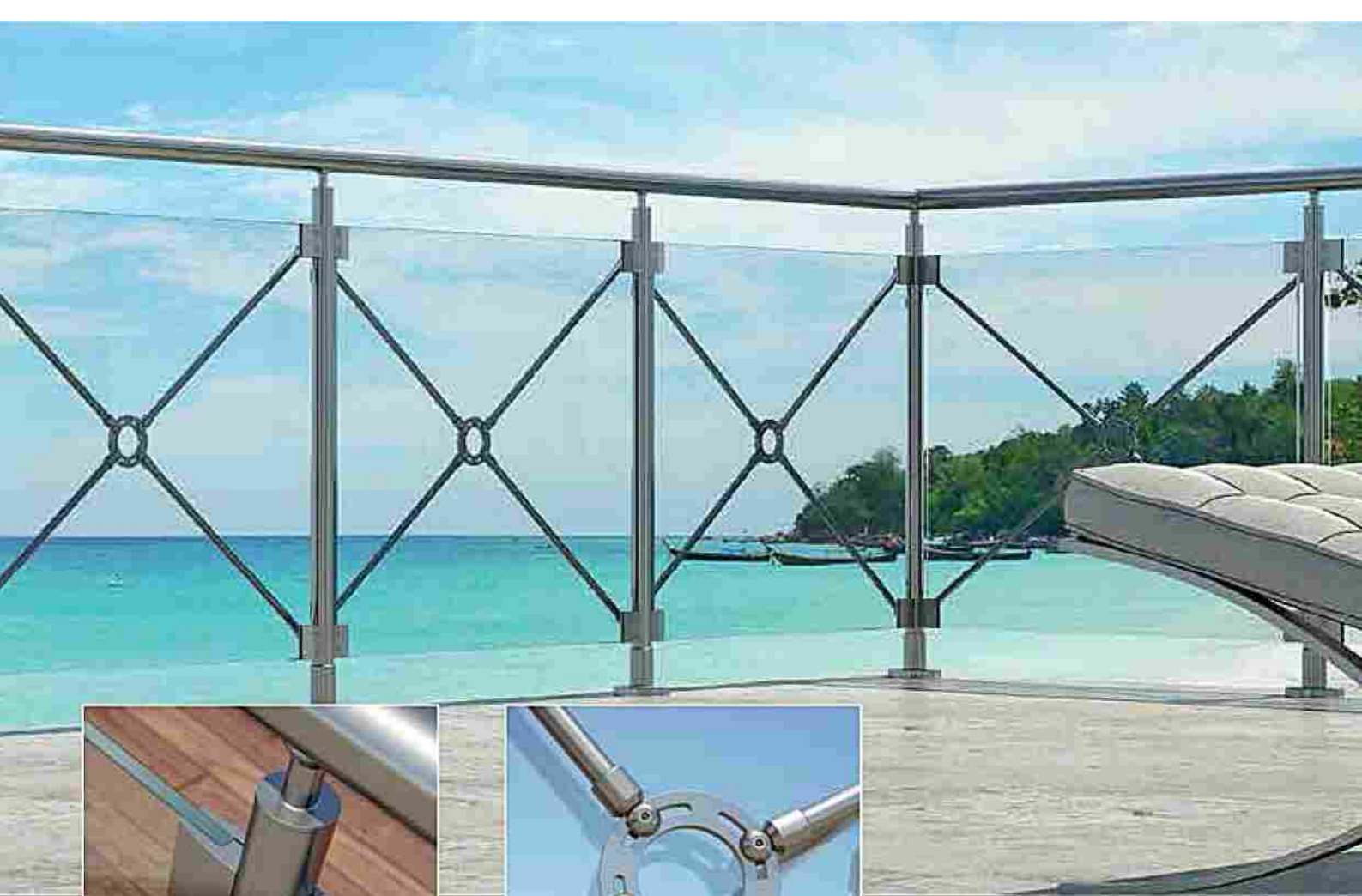

4168

Sujeción para cristal de 8 a 10 mm
Glass support 8-10mm



4314

Sujeción de pasamanos a columna

Connector for handrail
Ø50 with column Ø42



4322

Unión roseta con perfil F-26

Connector for glass
rossete with profile Ø16



4323

Articulación de esquina de F16 con F50-100

Adjustable corner connector
for profile Ø16 with F50-100 column

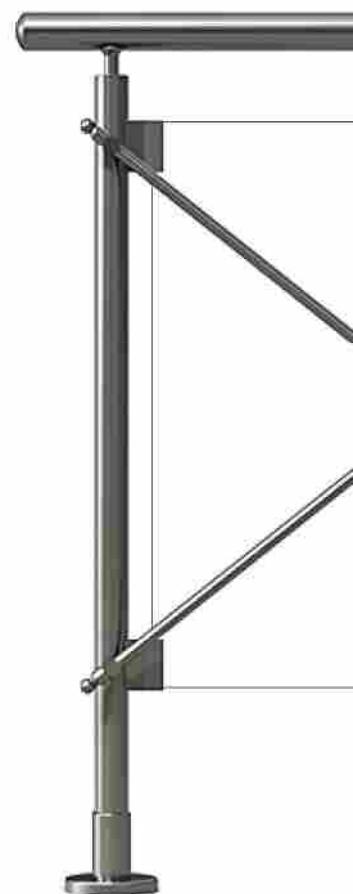



F50-100

Columna sujeción 42mm
Support column Ø42



4112

Pie de sujeción de 12cm
reforzado para columna F50-100
External support foot for Ø42
column to F50-100 column

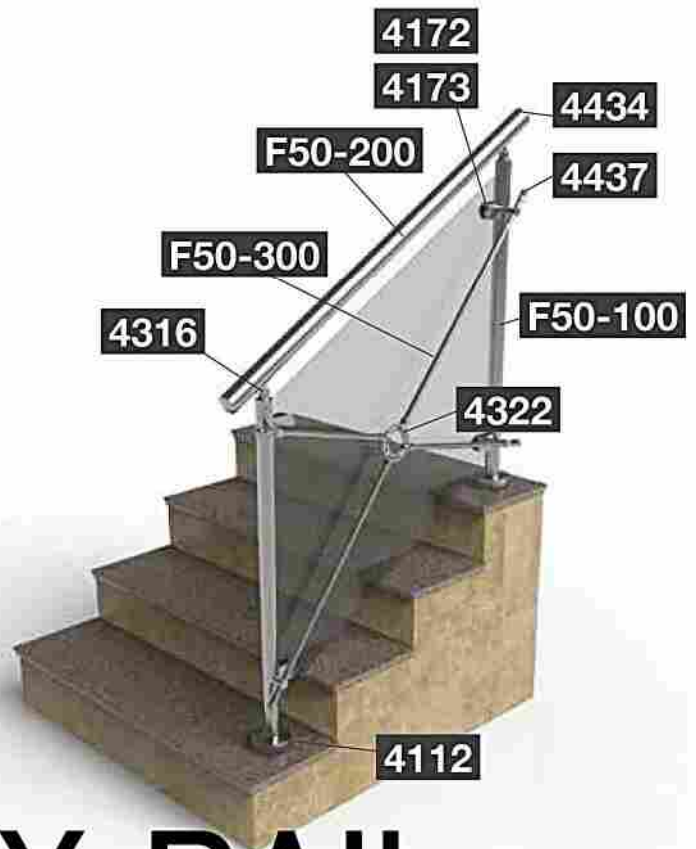

Horizon X-RAIL

42

Horizon X-RAIL



4172

Pinza de sujeción al cristal de 6-8 mm
INOX Glass support 6-8 mm

4173

INOX Glass support 8-10mm



4611

Roseta decorativa al cristal
Glass rosette Ø100



4167

Soporte columna F50-100
& F50-101 al suelo
Infloor support
for Ø42 columns



4329

Articulación esquina F-50 pasamanos
Adjustable corner
connector for column Ø50



4316

Sujeción pasamanos F50
a columna F50-100(escalera)
Connector for handrail Ø50
with column Ø42 (stairs)



4312

Unión columna F50-100
para perfil F16
Connector for F50-100
column with guide Ø16

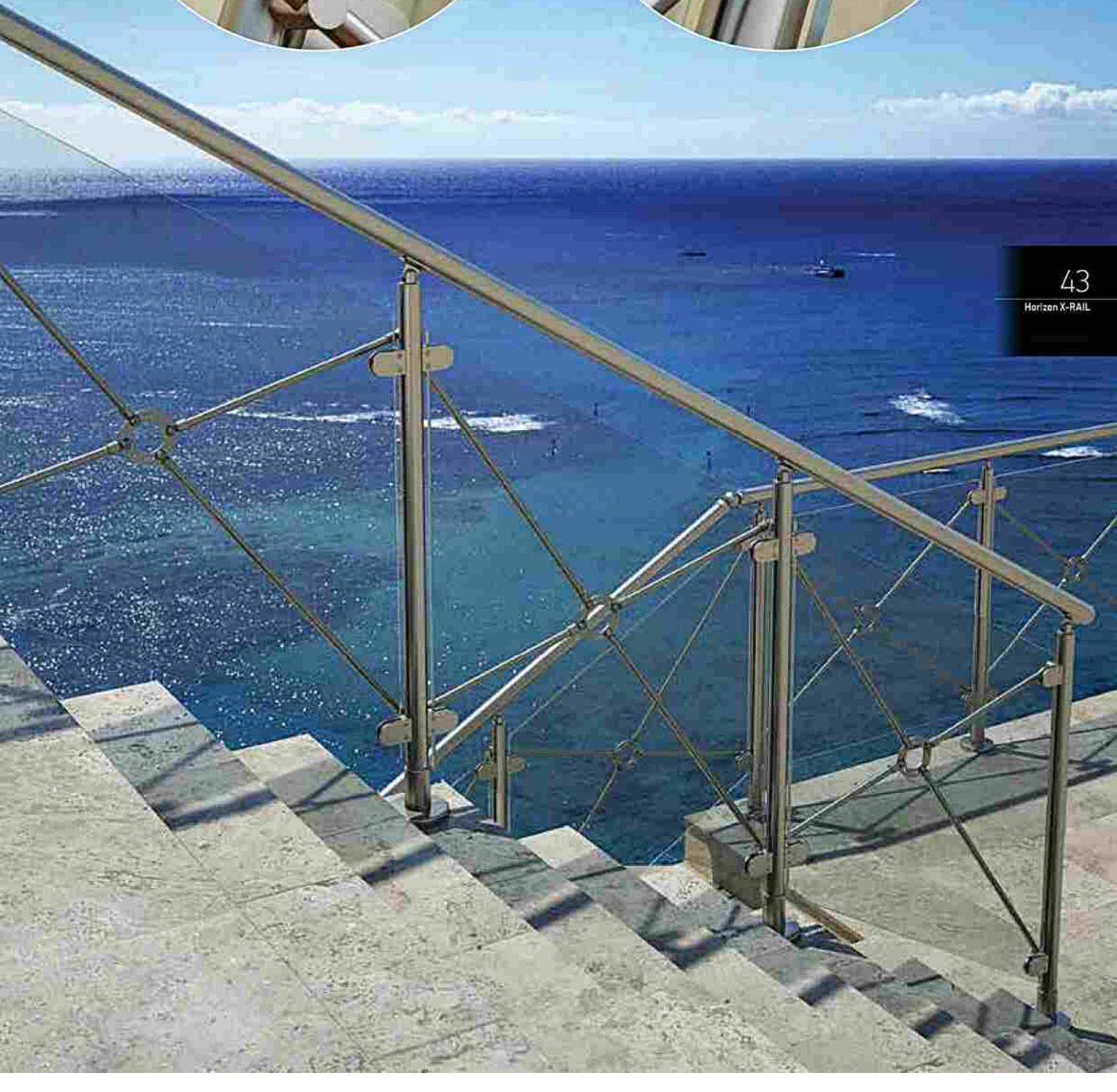



Horizon SQUARE X-RAIL

44

HorizonSQUAREX-RAIL

The base system Horizon X-Rail in conjunction with square blocks. The harmony of austere lines and unique view on the terrace.

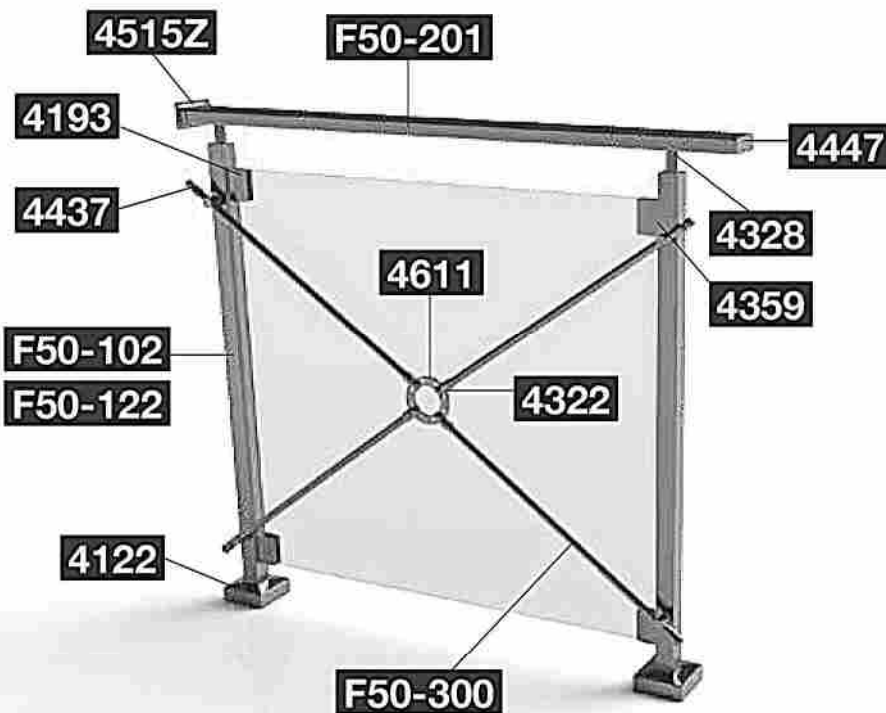

F50-102

Column sujeción 40 x 40
Support column 40x40

F50-122

Tapa columna
Cover for F50-102 column



F50-201

Pasamanos 30 x 80
Handrail 30x80

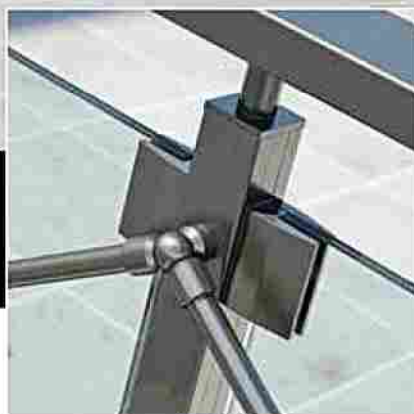

4193

Pinza plana para cristal 8-10mm
para columna F50-102,F50-106

Single glass support 8-10 mm
for F50-102/106 columns



4359

Conector de 16 a columna F50-12

Connector for F50-102
column with profile Ø16



4332

Unión en esquina de pasamanos
F50-201,F50-203

Adjustable corner connector for
F50-201/203 railtop



4360

Unión en esquina de perfil de 16
a columna F50-102

Adjustable corner
connector for profile Ø16

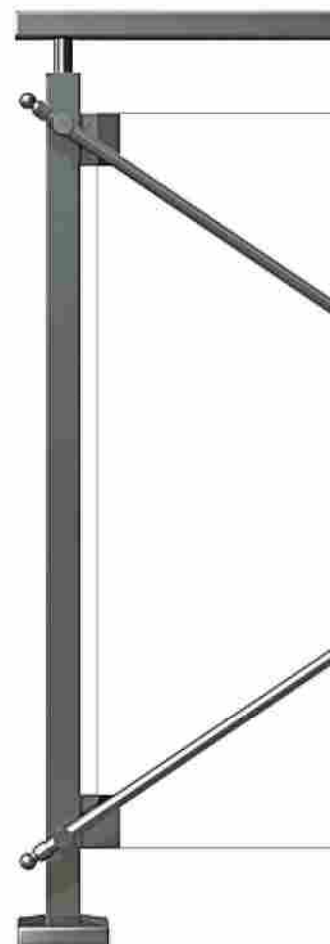



Horizon QUATTRO

46

Horizon QUATTRO

A different version of the main design, with square profiles. Limitless view and modern design.

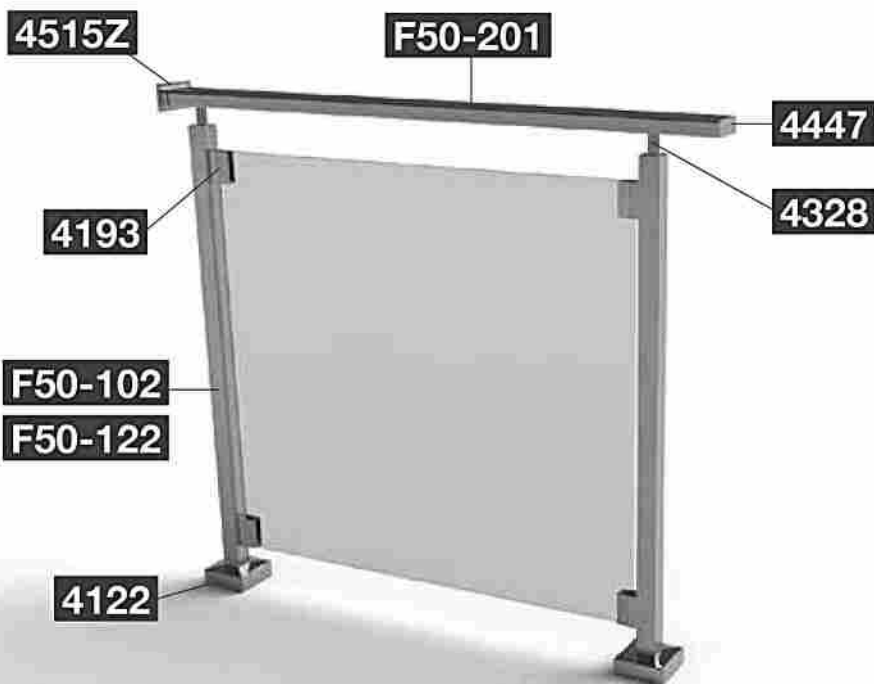

F50-102

Columna sujeción 40 x 40
Support column 40x40

F50-122

Tapa columna
Cover for F50-102 column



F50-201

Pasamanos 30 x 80
Handrail 30x80



4193

Pinza plana para cristal 8-10mm
para columna F50-102,F50-106
Single glass support 8-10 mm
for F50-102/106 columns



4328

Unión columna con pasamanos
F50-201
Support for F50-102 column
with F50-201 handrail



4332

Union en esquina de pasamanos
F50-201,F50-203
Adjustable corner connector for
F50-201/203 railtop



4122

Support foot for 40x40 column
Pie de sujeción para columna
F50-102 y F50-106

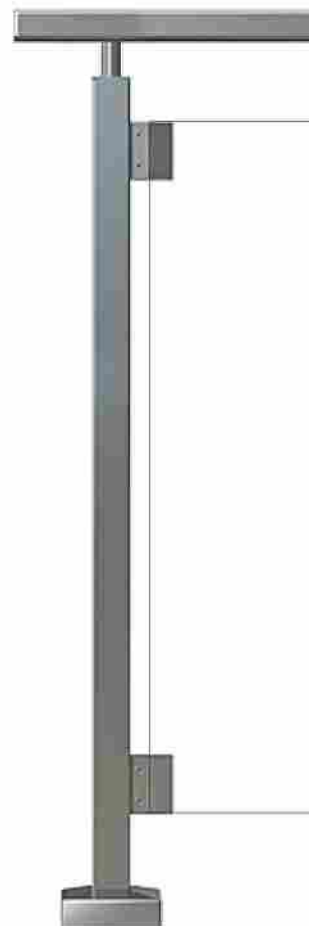



Horizon MAX

48

Horizon MAX

Combinación columna redonda con soporte de doble cristal que lo convierte en un conjunto con mucha visibilidad.

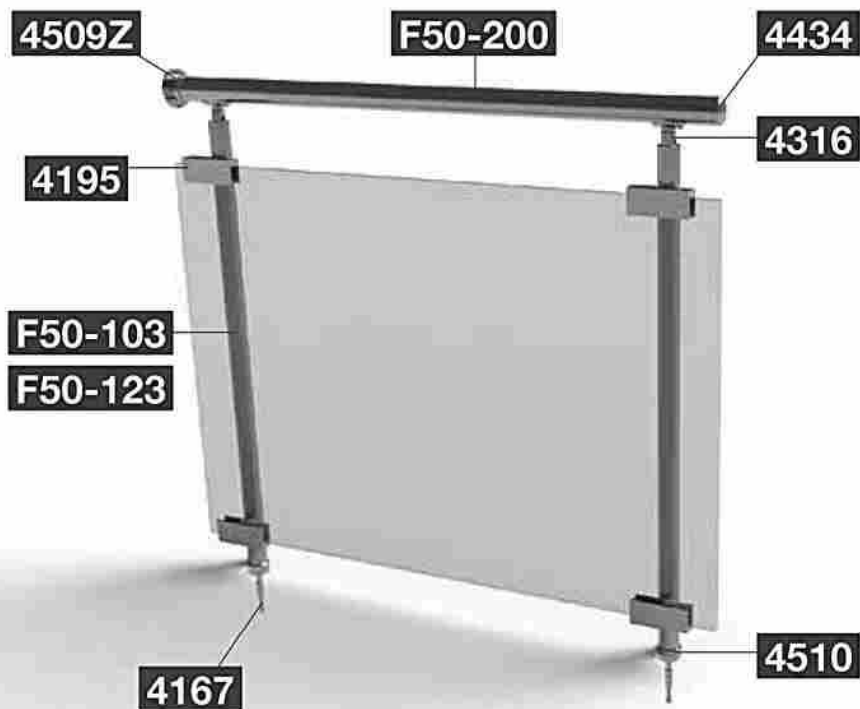

F50-103

Columna 42mm
Support column Ø42

F50-123

Columna sujeción perímetro 42mm
Cover for F50-103 column



F50-200

Pasamanos F-50
Handrail Ø50



4316

Sujeción pasamanos F50 a columna F50-100(escalera)
Connector for handrail Ø50 with column Ø42 (stairs)



4510

Embellecedor columna F50-100
Wall cover for column Ø42



4195

Soporte doble cristal 19-22 mm para columna de 42
Double glass support 19-22 mm



4219

Unión esquina pasamanos 90°
Ø50 Railtop connector 90°



4167

Soporte columna F50-100 & F50-101 al suelo
Infloor support for F50-100/101/103/107 columns

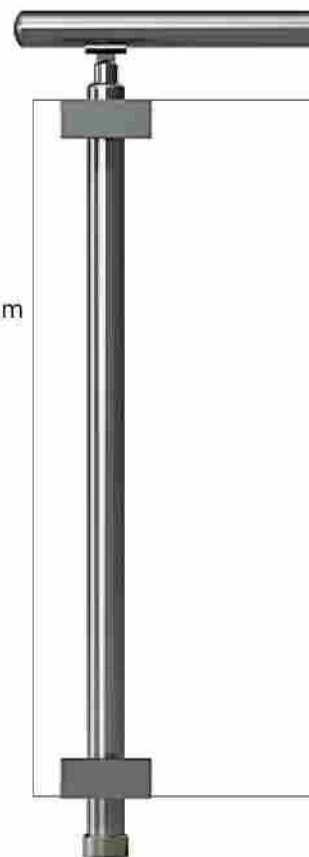



Horizon U-RAIL

50

Horizon U-RAIL

Absolutamente simétrico. Líneas finas que crean armonía con unas gran vistas al exterior.

Absolute symmetry. Fine line harmony creates a wonderful frame for your own balcony view.

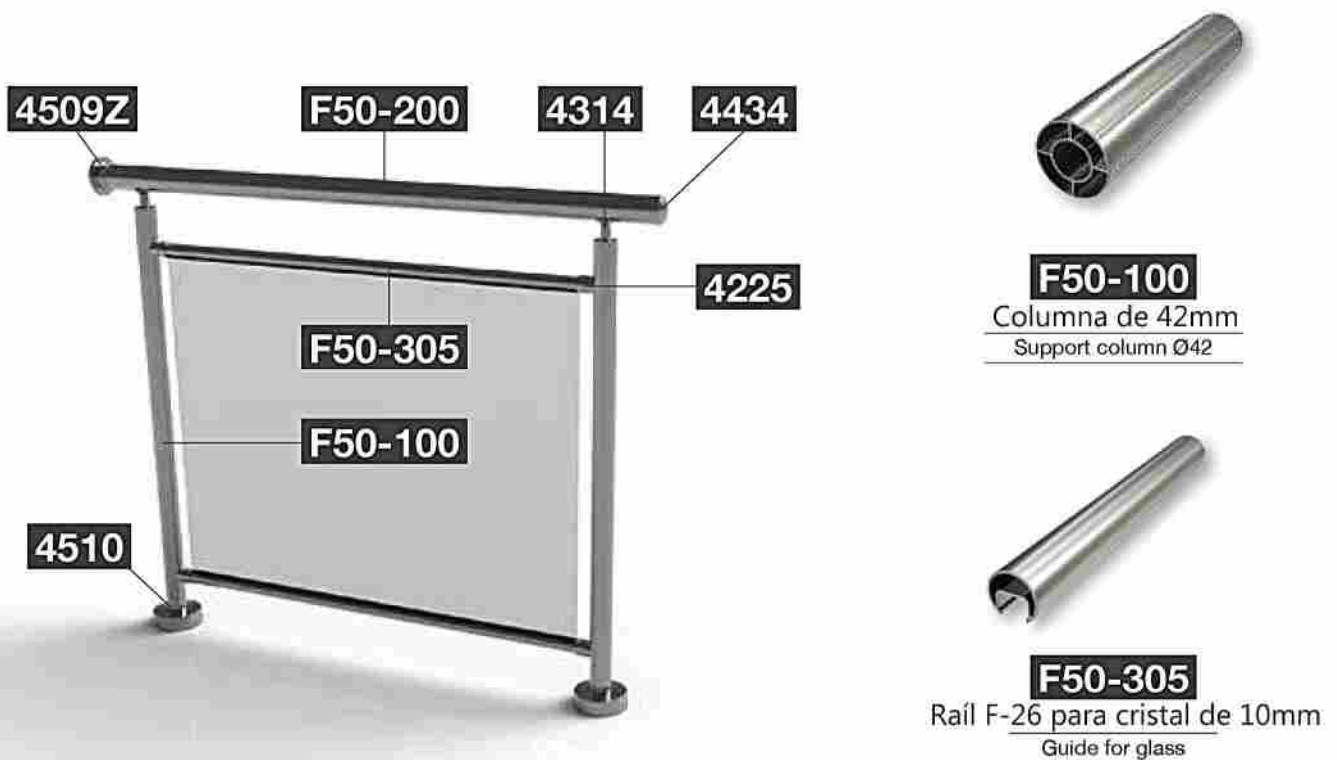



4225

Unión entre columna F50-100 y perfil F26

Connector for F50-100 column with profile Ø26



4252

Unión F50-100 con perfil 26mm

Connector for F50-100 Column with profile Ø26



4231

Unión pasamanos 90°

Ø50 Railtop corner connector to Ø42 column, 90°



4314

Sujeción pasamanos a columna

Connector for handrail Ø50 with column Ø42



4509Z

Pieza y embellecedor pasamanos

Ø50 Railtop wall cover





F50-100

Columna sujeción de 42mm
Support column Ø42



F50-200

Pasamanos F50 (50 mm)
Handrail Ø50



F50-305

Raíl F-26 para cristal de 10mm
Guide for glass

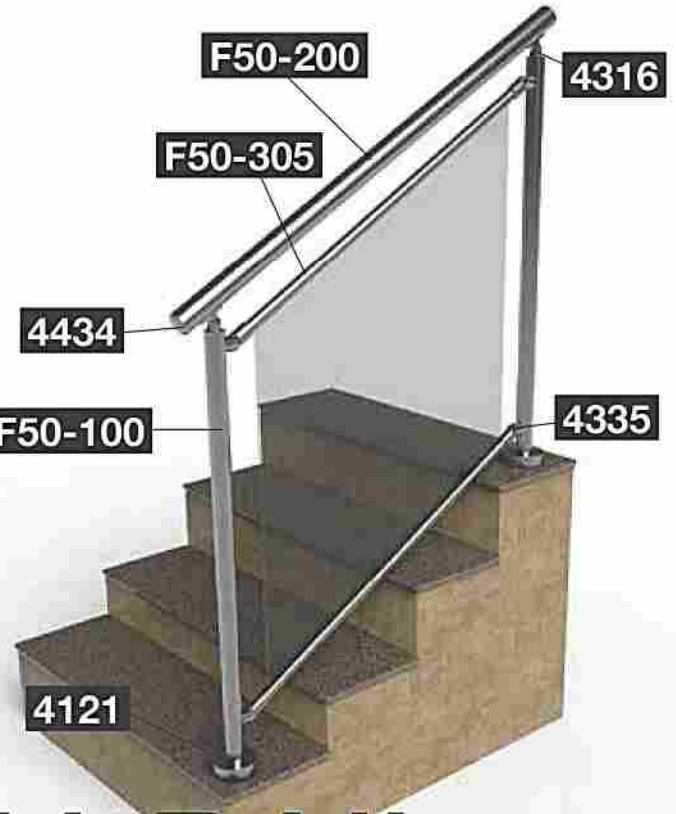

Horizon U-RAIL

52

Horizon U-RAIL

Absolutamente simétrico. Y una maravillosa armonía con líneas simétricas.

Absolute symmetry. Fine line harmony creates a wonderful frame for your own balcony view.



4316

Sujeción pasamanos F50 a columna F50-100(escalera)
Connector for handrail Ø50 with column Ø42 (stairs)



4121

Pie de sujeción para columna F50-100
Support foot for Ø42 column



4434

Tapa pasamanos F50-200
End cap for F50-200 handrail



4225

Unión entre columna F50-100 y perfil F26
Connector for F50-100 column with profile Ø26



4252

Unión F50-100 con perfil 26mm
Connector for F50-100 Column with profile Ø26



4335

Articulación columna F50-100 con perfil F26
Connector for F50-100 column with profile Ø26



53

Horizon U-RAIL





Horizon H-RINGS

54

Horizon H-RINGS

Hanging transparencies and concentric rings, offer an aesthesis of absolute symmetry. This is Horizon H-rings technology.

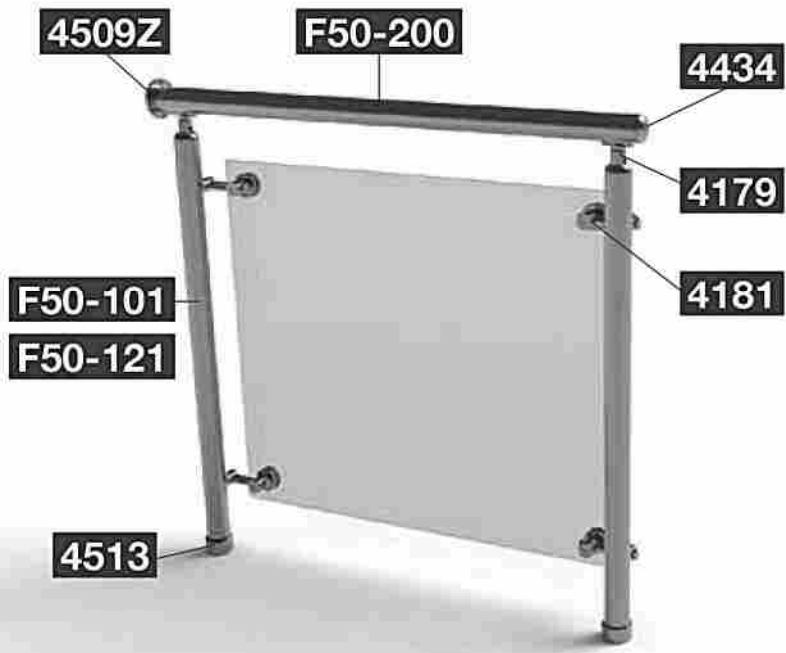

F50-101
Columna sujeción 50mm
Support column Ø50

F50-121
Tapa columna
Cover for F50-101 column



4179

Sujeción pasamanos
a columna F50-101
Support for F50-200
handrail-F50-101 column



4182

Soporte externo cristal
doble 8-10mm
Double glass support 8-10
mm for Ø50 column



4509Z

Embededor pasamanos
a pared
Ø50 Railtop wall cover



4181

Soporte externo cristal
doble 8-10 mm
Single glass support 8-10
mm for Ø50 column



4219

Unión esquina pasamanos 90°
Ø50 Railtop connector 90°



Horizon FRAME

56

Horizon FRAME

Gran visibilidad y diseño moderno
en plena armonía

Limitless view and modern design
in absolute accordance.

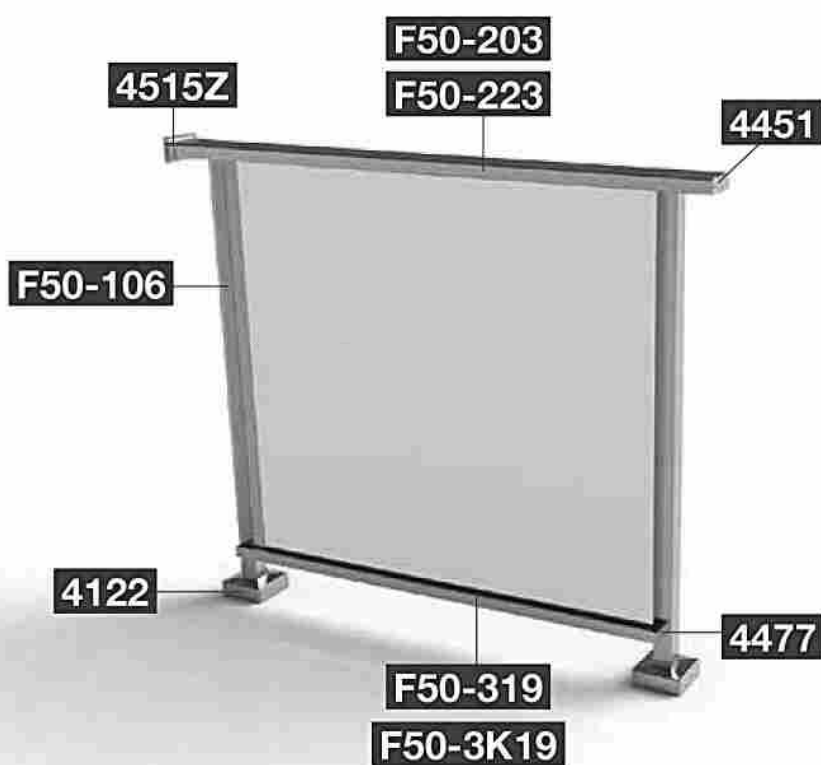

F50-203

Pasamanos de 30 x 40
Handrail 30x80 (dividable)

F50-223

Tapa para pasamanos dividido
Cover for dividable handrail F50-203



F50-106

Perfil cuadrado 40 x 40
Support column 40x40



F50-319
Pasamanos para cristal de 10-12mm
Guide for glass 10-12 mm



4122
Pie de sujeción para columna F50-102 y F50-106
Support foot for 40x40 column

F50-3K19
Tapa perfil
Rail cover



4332
Unión en esquina de pasamanos
F50-201, F50-203
Adjustable corner connector for
F50-201/203 railtop



4477
Tapa pasamanos F50-201
End cap for F50-319 guide

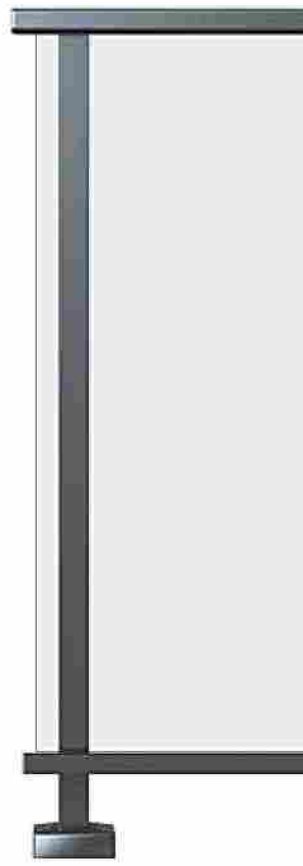



Horizon BLADE

58

Horizon BLADE

Combination of specially designed double column with glass supports for a delicate result.

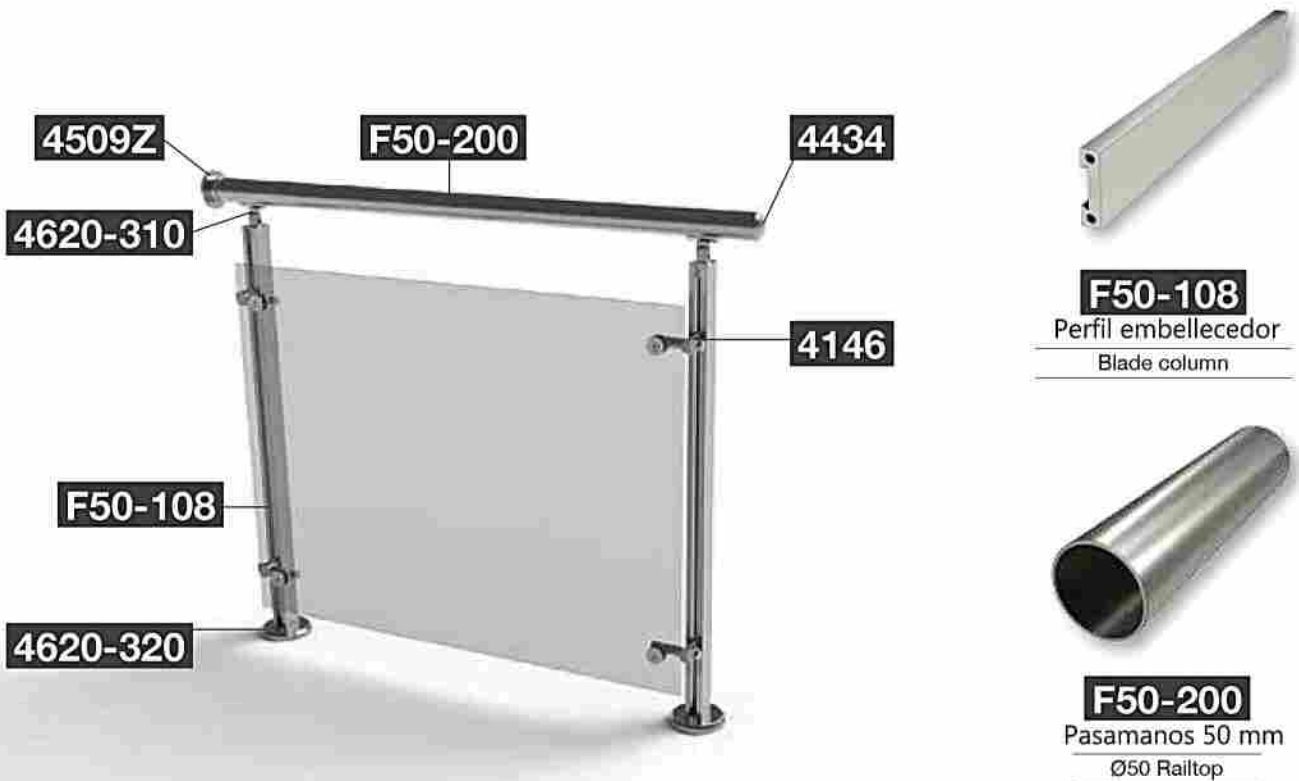

F50-108
Perfil embellecedor
Blade column

F50-200
Pasamanos 50 mm
Ø50 Railtop

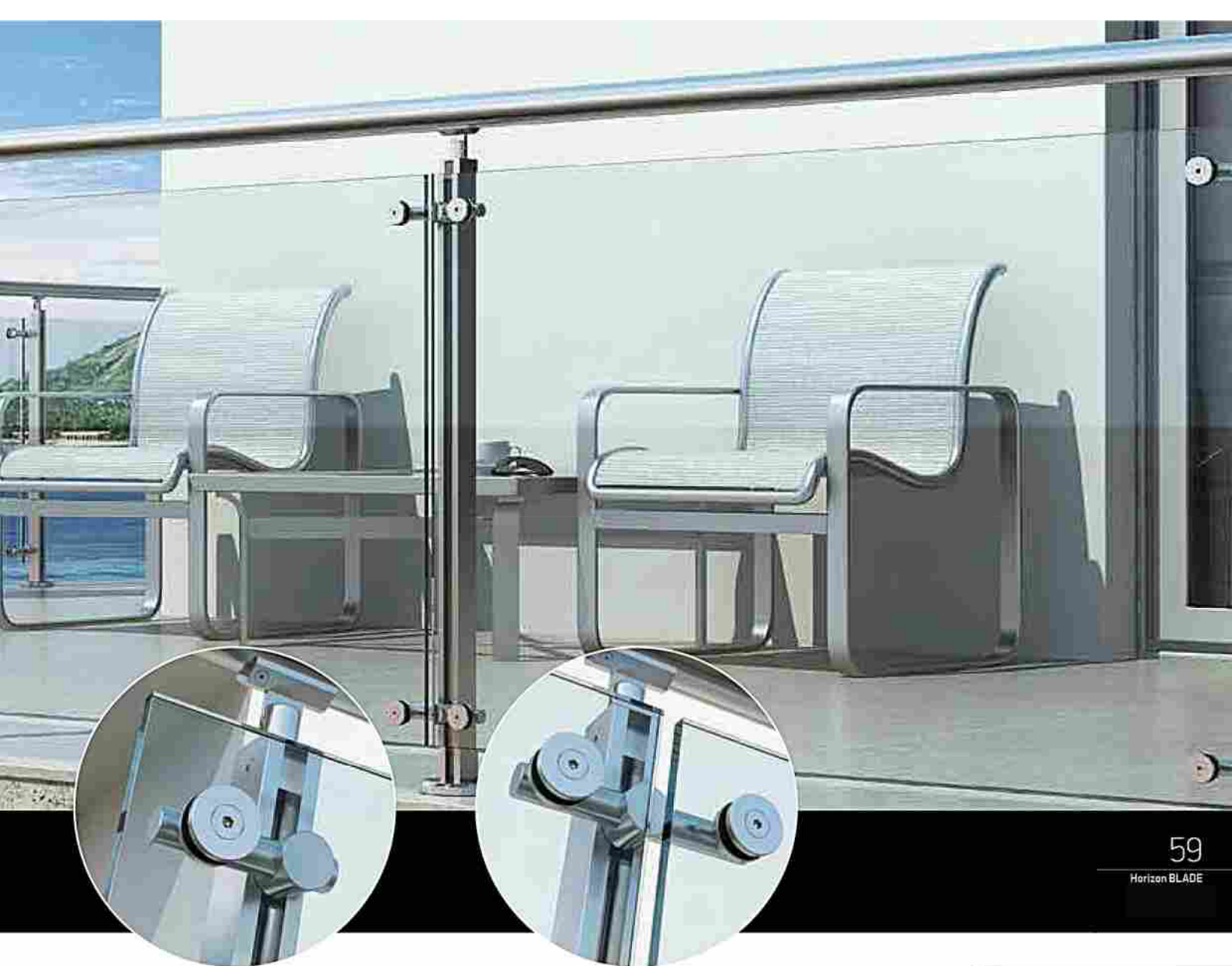

4620-310

Soporte de columna a pasamanos

Support for handrail Ø50 -
BLADE column



4146

Soporte simple para cristal 8-10 mm

Single glass support 8-10 mm
for BLADE column



4620-320

Soporte de sujeción de F50-108

Support foot for F50-108 Column



4147

Soporte doble para cristal 8-10mm

Double glass support 8-10 mm
for BLADE column

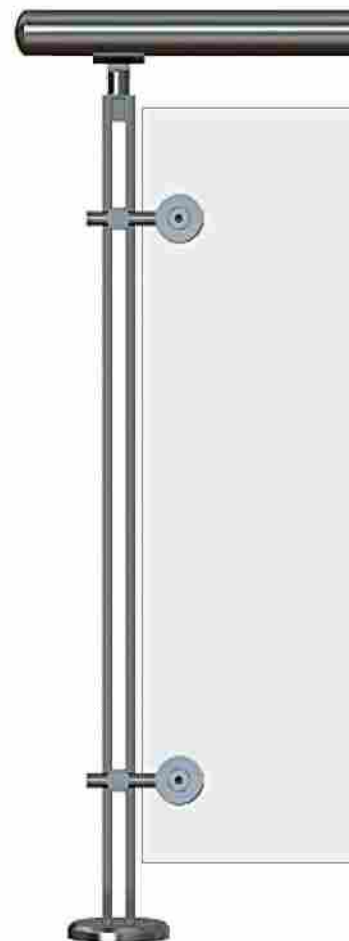



Vertical

60
Vertical

Where the modern meets the classic.
Simply enjoy the dynamic combination!



F50-300

Perfil F-16 x 1,3 mm de grosor
Profile Ø16X1.3



F50-100

Columna sujeción 42mm
Support column Ø42

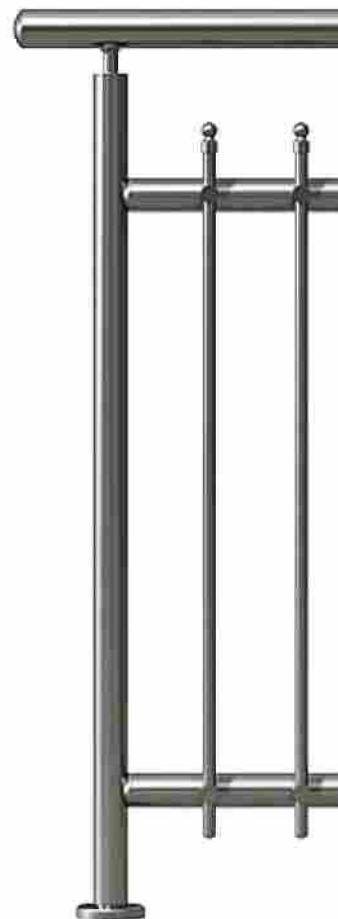

4312

Unión pasamanos a columna

Connector for F50-100
column with guide Ø16



4224

Unión columna F50-100
(conexión vertical y horizontal)

Connector for column
with column F50-100

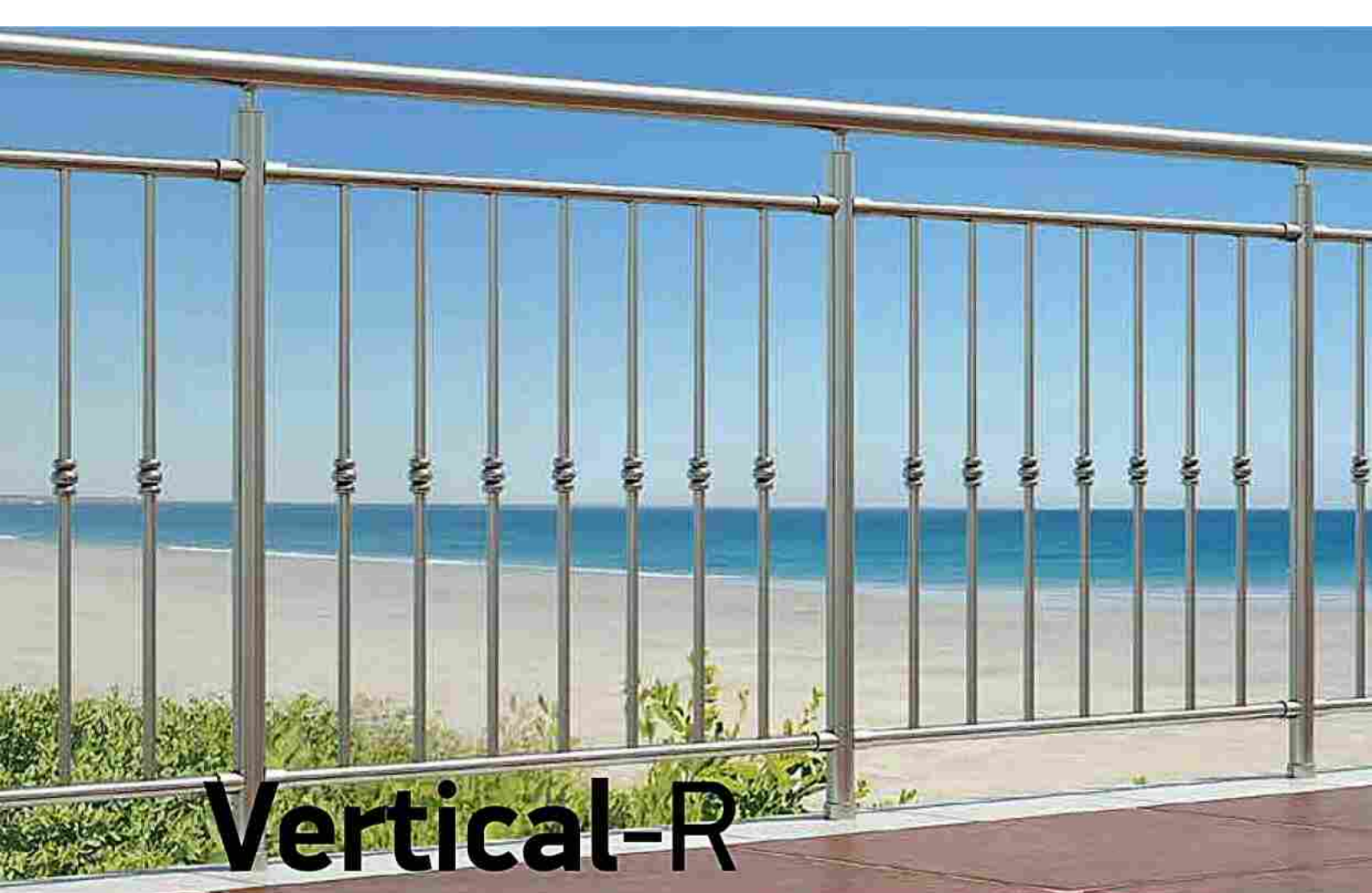

Vertical-R

62

Vertical-R

Features

Es una solución alternativa para diseños clásicos. Finas líneas de Luxury

One more alternative solution for the lovers of classic designs. Delicate luxury in fine lines.



F50-306

Οδηγός διάτρητος Ø26
Perforated guide Ø26



F50-303

Προφίλ Ø16
με υποδοχή για βίδα
Profile Ø16 with screw hole



4314

Sujeción pasamanos a columna

Connector for handrail
Ø50 with column Ø42



4618

Decoración perfil para escalera F-16

Glass rosette for profile Ø16



4231

Unión pasamanos en 90°

Ø50 Railtop corner connector
to Ø42 column, 90°



4225

Unión columna F50-100 y F-26

Connector for F50-100
column with profile Ø26



4252

Unión columna F50-100 con perfil 26mm

Connector for F50-100
Column with profile Ø26





Vertical-D

Here's how beautiful and smart traditional railing solutions can satisfy today's needs.



F50-308
Columna cuadrada 12x12x12
Column 12x12x2



4328
Unión columna con pasamanos F50-201
Support for F50-102 column
with F50-201 handrail



4240

Unión de columna con raíl F50-307 con F50-102

Connector for F50-307 guide with F50-102 column



4332

Unión en esquina de pasamanos F50-201,F50-203

Adjustable corner connector for F50-201/203 railtop



4514

Embelecedor de columna F50-102

Wall cover for F50-102 column



4515

Unión pasamanos a pared F50-201,F50-203

Wall cover for F50-201/203 handrail



4447

Tapa de pasamanos F50-201

End cap for F50-201 handrail





Vertical-Q

66

Vertical-Q

Smart match of traditional and modern. A classic railing in simple lines.



F50-203

Pasamanos 30 x 80
Handrail 30x80 (dividable)

F50-223

Tapa para pasamanos dividido
Cover for dividable handrail F50-203



F50-106

Perfil cuadrado 40x40
Support column 40x40

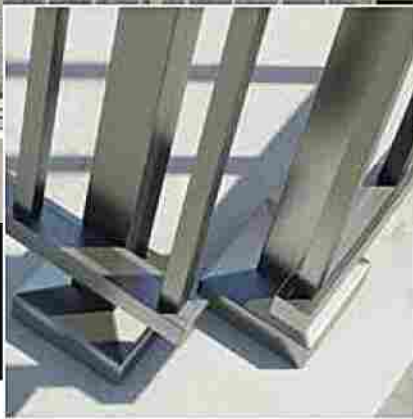

F50-319

Pasamanos para cristal de 10-12mm
Guide for glass 10-12 mm



F50-311

Perfil tapa rail F50-310 y
pasamanos F50-203
Cover for F50-310 guide
and F50-203 handrail



4332

Unión en esquina de pasamanos
F50-201,F50-203
Adjustable corner connector for
F50-201/203 railtop

F50-3K19

Tapa perfil
Rail cover



4451

Tapa pasamanos F50-203
F50-203 Railtop end cover



4122

Pie de sujeción para columna F50-102 y F50-16
Support foot for 40x40 column

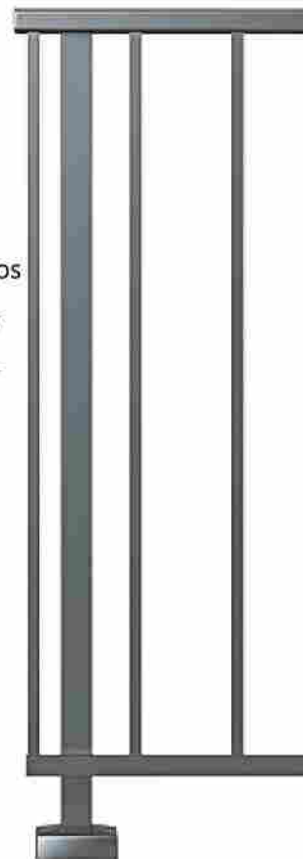



Slim Line

68

Slim Line

Diseño simétricamente minimalista que incorpora un diseño arquitectónico.

Slim Line edition features a more minimalist symmetrical look incorporated in every architectural design.



F50-209

Perfil pasamanos F-40
Handrail Ø40



F50-100

Columna sujeción 42mm
Support column Ø42



F50-300

Perfil F-16 x 1,3 mm de grosor
Profile Ø16x1.3



4367

Conector para pasamanos
de 40mm
Adjustable corner connector
for handrail Ø40



4112

Pie de sujeción de 12 cm
reforzado para columna F50-100
External support foot
for Ø42 column



4368

Sujeción de pasamanos a
columna de 42mm
Support for handrail Ø40 -
column Ø42 (stairs)



4437

Decoración final para escalera F-16
End cover for profile Ø16



4312

Unión columna F50-100
para perfil F16
Connector for F50-100
column with guide Ø16

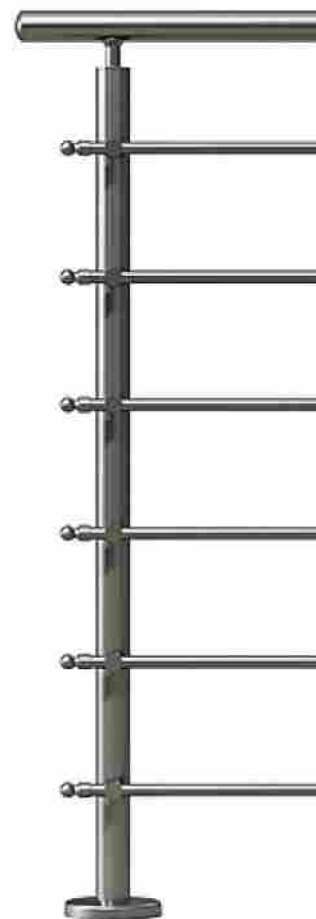





Classic European

La classica European es una barandilla que ofrece una estabilidad, ofreciendo infinidad de opciones en centros comerciales, y en edificios de todo tipo.

Classic European is an established glass railing solution, offering timeless balustrades to commercial or residential buildings where no balconies are available.

Classic European

72

Classic European

Distinguished by timeless elegance and reliable safety, Classic European railings perfectly match the contemporary needs of the end user.



F50-319

Pasamanos para cristal de 10-12mm
Guide for glass 10-12 mm



4259

Conector para la guia
F50-319
Connector for
F50-319 guide



4478

Tapa final perfil F50-319(par)
End cap for F50-319 guide
(perforated)



4971

Calibre para los agujeros para F50-318
Holes calibre for F50-319

F50-3K19

Tapa perfil
Rail cover



4477

Tapa rail F50-319
End cap for F50-319 guide



E4912

Gomas para 10 mm de cristal
F50-319 rail gasket
for 10 mm glass



US530-1/2/3PRM

Gomas para 12mm de cristal
F50-319/203 rail
gasket for 12 mm glass



El sistema clásico Europeo se coloca montandolo por un lateral, se puede fijar a la pared o el marco sin visibilidad de los tornillos. Con la opción de un carril inferior.

The Classic European is placed side-mounted, fixed either on the wall or the frame, with no visible bolts and wall fixings, with the choice of a bottom rail and/or the glass extended over the frame.

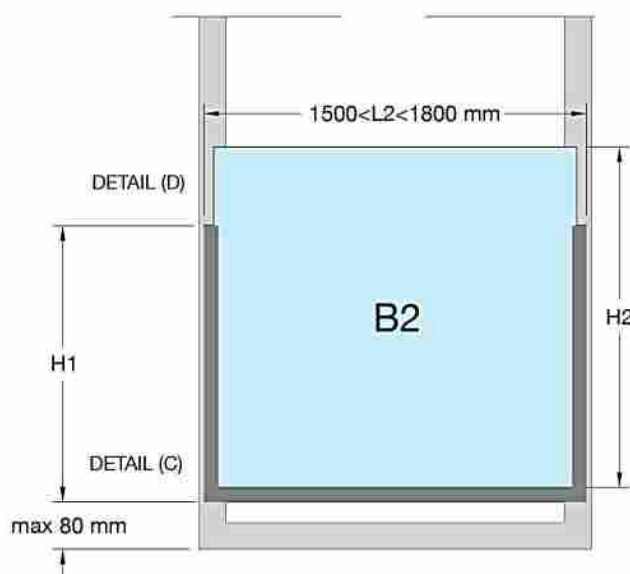
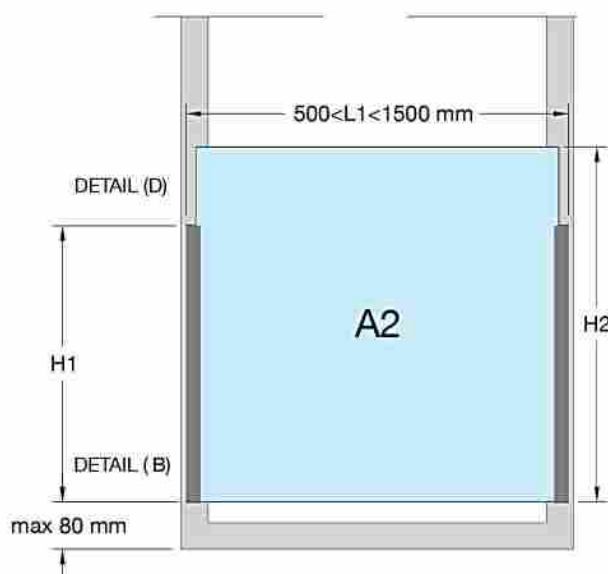
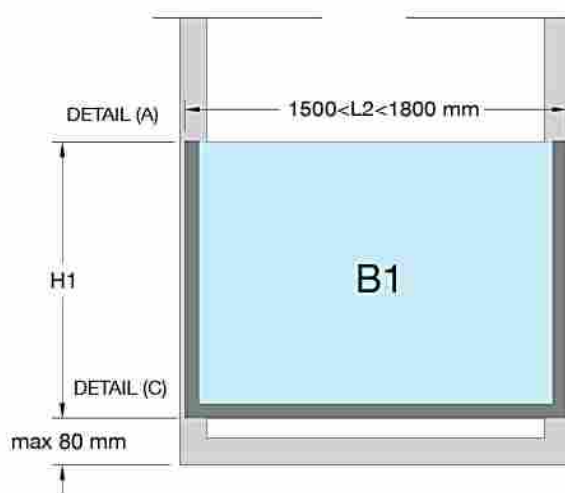
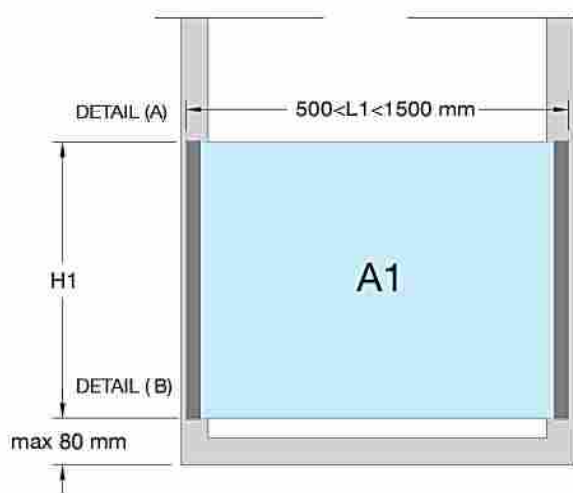
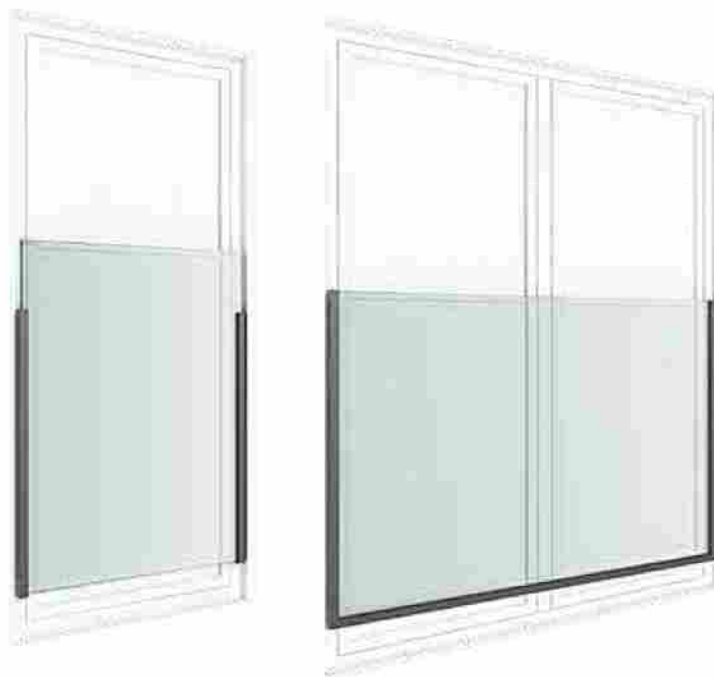

$400 < H1 \leq 1200\text{ mm}$
 $500 < L1 \leq 1500\text{ mm}$

$1200\text{ mm} < H2 \leq 1500\text{ mm}$
 $1500\text{ mm} < L2 \leq 1800\text{ mm}$

Code:Código
Weight:Peso

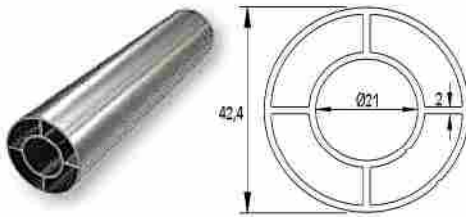

COLUMNA SUJECION Ø 42 mm
Support column Ø42

/ Code	F50-100
/ Weight	1025 gr/m

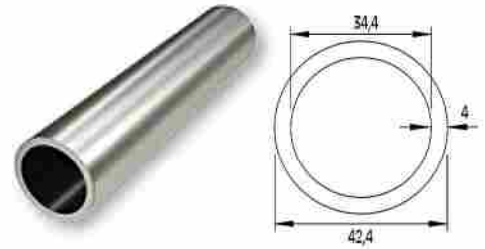

COLUMNA DE 42 MM.
Support column Ø42

/ Code	F50-104
/ Weight	1303 gr/m



COLUMNA SUJECIÓN DE 50mm
Support column Ø50

/ Code	F50-101
/ Weight	1915 gr/m

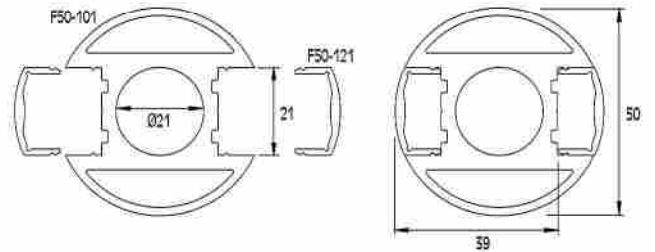

TAPA EMBELLECEDORA DE COLUMNA
Cover for F50-101 column

/ Code	F50-121
/ Weight	152 gr/m



COLUMNA SUJECION 40 X 40
Support column 40x40

/ Code	F50-102
/ Weight	1153 gr/m

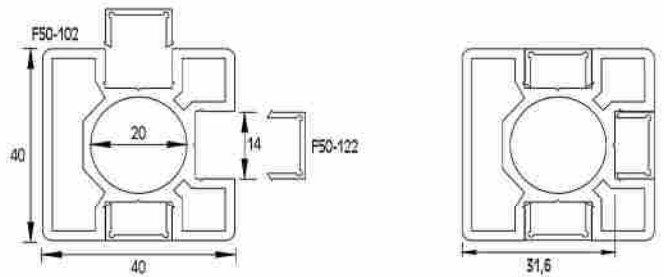

TAPA EMBELLECEDORA COLUMNA F50-102
Cover for F50-102 column

/ Code	F50-122
/ Weight	86 gr/m



COLUMNA SUJECIÓN PERIMETRO 42 mm
Support column Ø42

/ Code	F50-103
/ Weight	980 gr/m

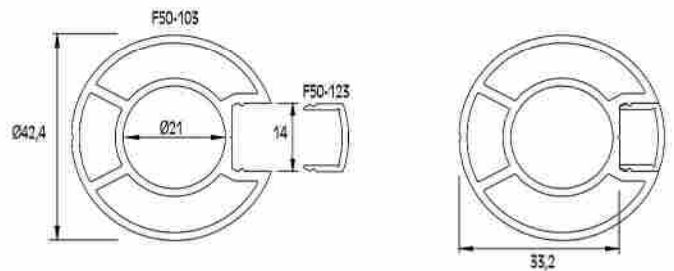

TAPA EMBELLECEDORA DE COLUMNA F50-103
Cover for F50-103 column

/ Code	F50-123
/ Weight	90 gr/m

Code:Código
Weight:Peso

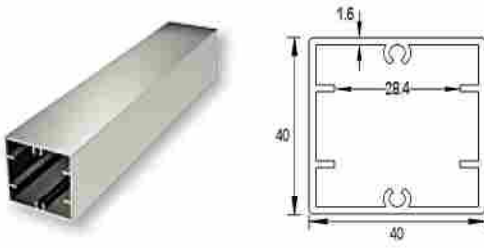

PERFIL CUADRADO 40 X 40
Support column 40x40

/ Code	F50-106
/ Weight	794 gr/m

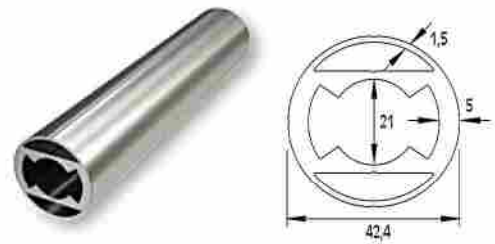

COLUMNA DE 42 MM
Support column Ø42 (heavy-duty)

/ Code	F50-107
/ Weight	1647 gr/m

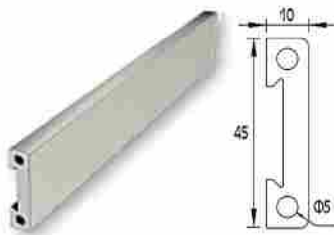

PERFIL EMBELLECEDOR
Blade column

/ Code	F50-108
/ Weight	851 gr/m

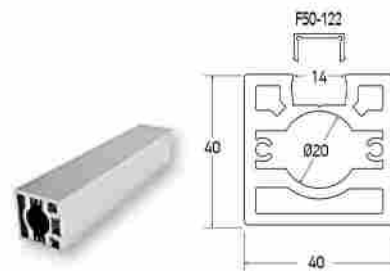

SOPORTE DE COLUMNA 40 X 40
Support column 40x40 (without cap)

/ Code	F50-109
/ Weight	1968 gr/m

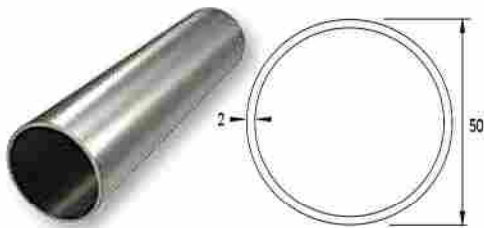

PASAMANOS F-50 (Ø50mm)
Handrail Ø50

/ Code	F50-200
/ Weight	815 gr/m

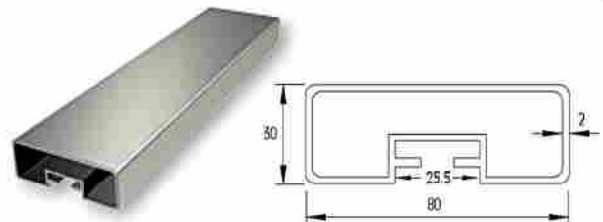

PASAMANOS 30 X 80
Handrail 30x80

/ Code	F50-201
/ Weight	1350 gr/m



PASAMANOS DIVIDIDO DE 30 x 80
Handrail 30x80 (dividable)

/ Code	F50-203
/ Weight	740 gr/m

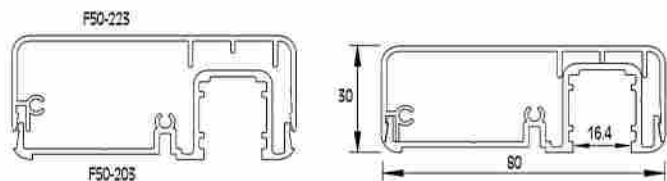

PASAMANOS DIVIDIDO 30 X 80
Cover for dividable handrail F50-203

/ Code	F50-223
/ Weight	610 gr/m

Code:Código
Weight:Peso

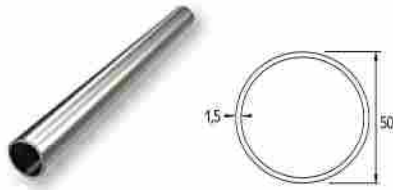

PASAMANOS F-50 (Ø50mm), GROSOR 1,5
Handrail Ø50

/ Code	F50-205
/ Weight	617 gr/m

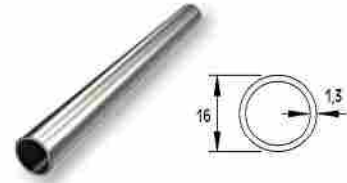

PERFIL F-16 X 1,3 MM DE GROSOR
Profile Ø16X1,3

/ Code	F50-300
/ Weight	162 gr/m

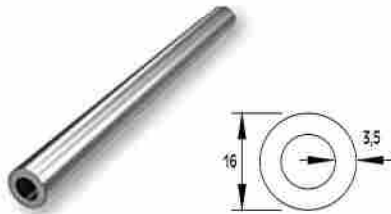

PERFIL F-16 X 3,5 MM DE GROSOR
Profile Ø16X1,3

/ Code	F50-301
/ Weight	370 gr/m

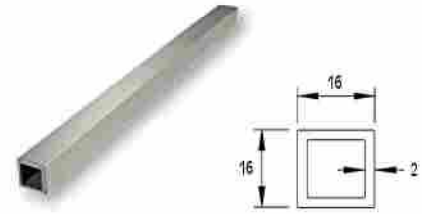

RAIL CUADRADO 16 X 16 X 2 MM
Square 16x16x2

/ Code	F50-302
/ Weight	302 gr/m



RAIL ESPECIAL 16MM
Profile Ø16 with screw hole

/ Code	F50-303
/ Weight	262 gr/m

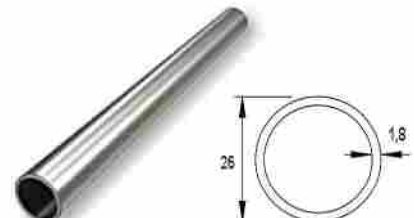

PERFIL Ø26mm inox
Profile Ø26x1,8

/ Code	F50-304
/ Weight	370 gr/m

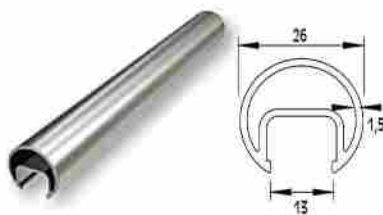

RAIL F-26 PARA CRISTAL DE Ø10 MM.
Guide for glass

/ Code	F50-305
/ Weight	394 gr/m

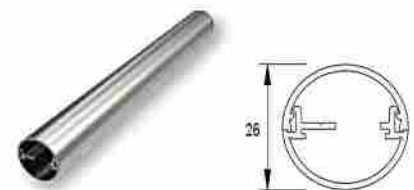

RAIL ESPECIAL Ø26 MM PARA F50-303 AGUJERADO
Perforated Ø26 guide for F50-303 profile

/ Code	F50-306
/ Weight	368 gr/m



RAIL Ø30 MM
Guide Ø30

/ Code	F50-307
/ Weight	442 gr/m

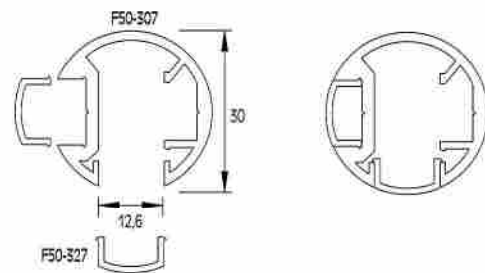

TAPA EMBELLECEDORA DE F50-307
Rail cover

/ Code	F50-327
/ Weight	68 gr/m

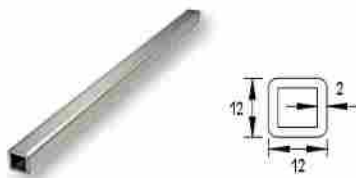

COLUMNA CUADRADA DE 12 X 12 X 2mm
Column 12x12x2

/ Code	F50-308
/ Weight	215 gr/m

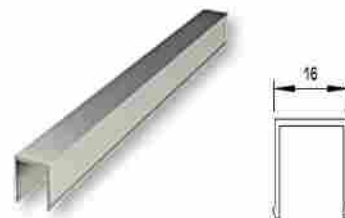

PERFIL TAPA RAIL F50-310 Y PASAMANOS F50-203
Cover for F50-310 guide and F50-203 handrail

/ Code	F50-311
/ Weight	176 gr/m



PERFIL INFERIOR PARA CRISTAL DE 10-12MM
Guide for glass 10-12mm

/ Code	F50-319
/ Weight	687 gr/m

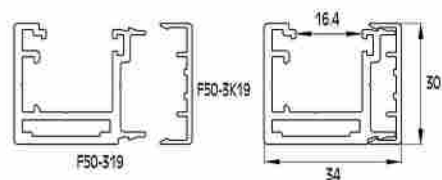

TAPA PERFIL

Cover for guide F50-319

/ Code	F50-3K19
/ Weight	160 gr/m

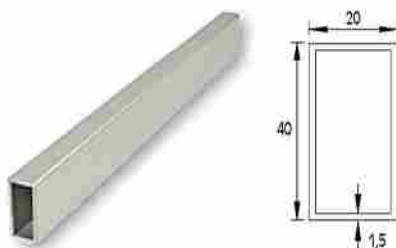

PERFIL 40 X 20
40x20 Profile

/ Code	59-009
/ Weight	462 gr/m

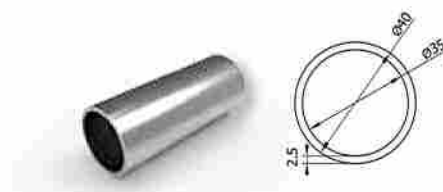

PERFIL PASAMANOS F40
Handrail Ø40

/ Code	F50-209
/ Weight	800 gr/m

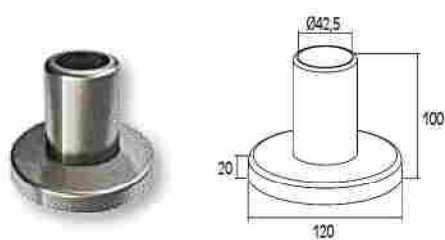

PIE DE SUJECCIÓN DE 12 CM. REFORZADO
PARA COLUMNA F50-100

External support foot for Ø42 column

/ Code **4112**

/ Pack. 20 /pcs.

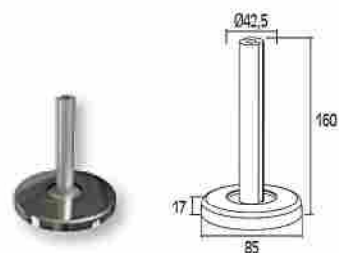

PIE DE SUJECION PARA COLUMNA F50-100

Support foot for Ø42 column

/ Code **4115**

/ Pack. 40 /pcs.

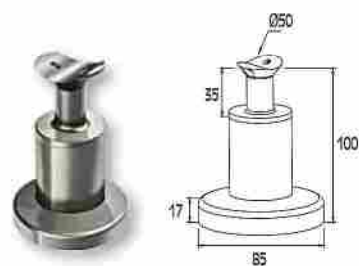

SOPORTE DE 8.5 CM PASAMANOS A MURO

Support for F50-200 railtop

/ Code **4116**

/ Pack. 20 /pcs.

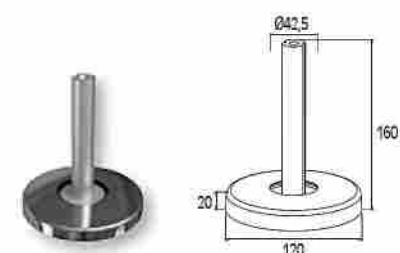

PIE DE SUJECCIÓN DE 12CM PARA COLUMNA F50-100

Support foot for Ø42 column

/ Code **4117**

/ Pack. 20 /pcs.

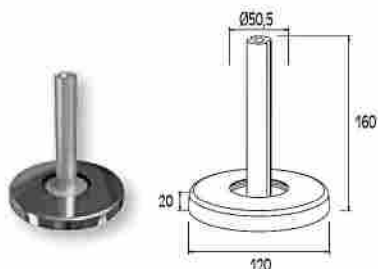

PIE DE SUJECCIÓN DE 12 CM. PARA COLUMNA F50-101

Support foot for Ø50 column

/ Code **4119**

/ Pack. 20 /pcs.

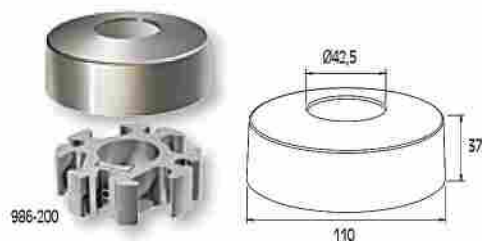

PIE DE SUJECION PARA COLUMNA F50-100

Support foot for Ø42 column

/ Code **4121**

/ Pack. 20 /pcs.

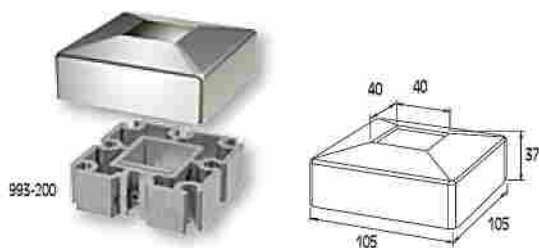

PIE DE SUJECION PARA COLUMNA F50-102, F50-106

Support foot for 40x40 column

/ Code **4122**

/ Pack. 20 /pcs.

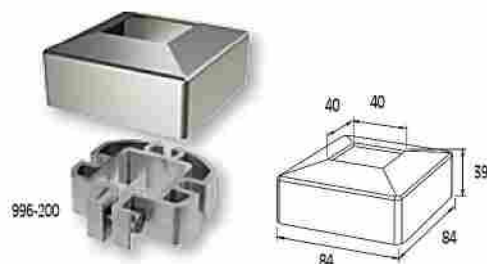

SOPORTE PARA COLUMNA DE 40 X 40

Support foot for 40x40 column

/ Code **4124**

/ Pack. 20 /pcs.

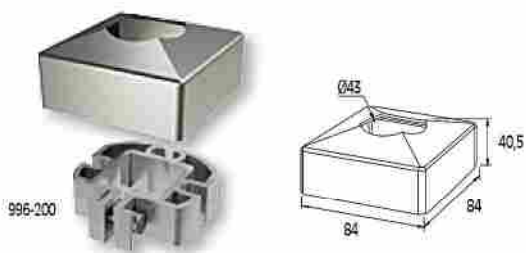

996-200

SOPORTE PARA COLUMNA DE 42
Support foot for Ø42 column

/ Code	4126
/ Pack.	20 /pcs.

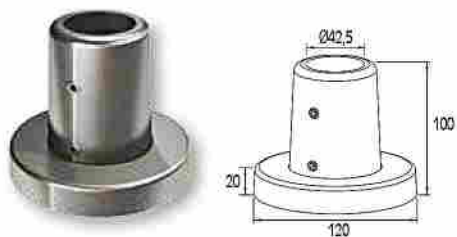

SOPORTE REFORZADO PARA COLUMNA DE 42
Heavy duty support foot for Ø42 column

/ Code	4127
/ Pack.	20 /pcs.

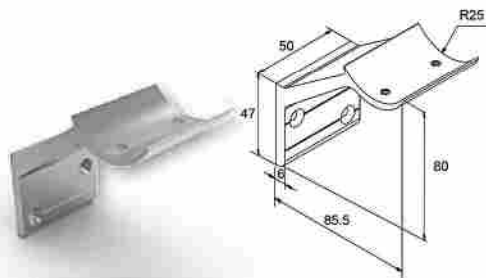

SOPORTE CONEXION PASAMANOS F50-200 A COLUMNA
Fixed wall support for F50-200 handrail

/ Code	4134
/ Pack.	20 /pcs.

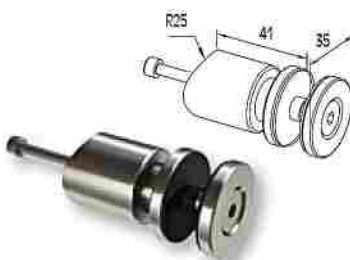

SOPORTE CRISTAL 8-10 MM PARA COLUMNA F50-100
Glass support 8-10mm for F50-101 column

/ Code	4137
/ Pack.	10 /pcs.

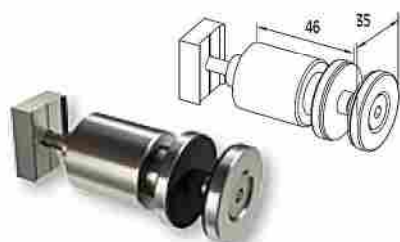

SOPORTE CRISTAL 8-10 MM PARA COLUMNA 4620
Single Glass support 8-10 mm for BLADE column

/ Code	4138
/ Pack.	10 /pcs.

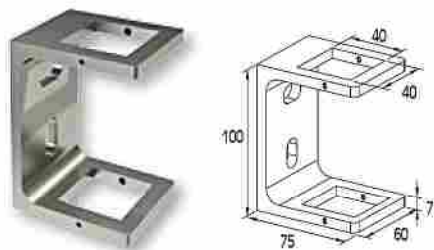

SOPORTE EXTERIOR PARA COLUMNA 40 X40
External support for 40x40 column

/ Code	4139
/ Pack.	12 /pcs.

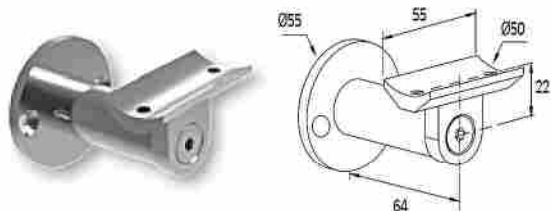

SOPORTE A PARED PARA PASAMANOS F50-200
Wall support for F50-200 handrail

/ Code	4140
/ Pack.	20 /pcs.

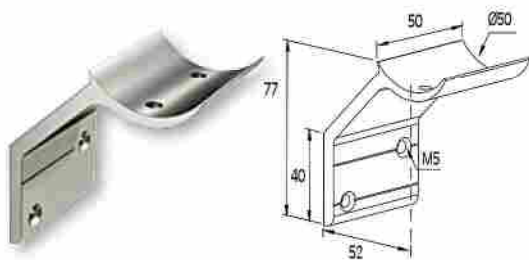

SOPORTE A PARED PARA PASAMANOS F50-200
Fixed wall support for F50-200 handrail

/ Code	4141
/ Pack.	20 /pcs.

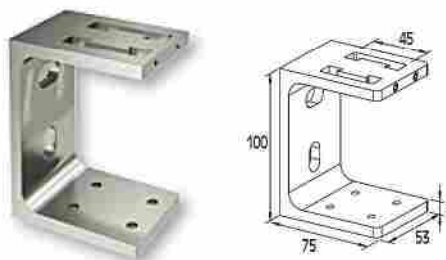

SOPORTE EXTERIOR PARA COLUMNA F50-108
External support for BLADE column

/ Code	4142
/ Pack.	12 /pcs.

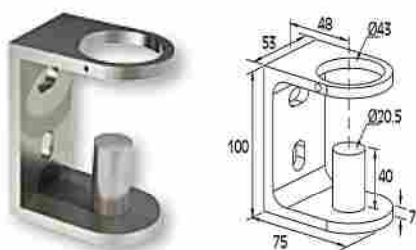

SOPORTE EXTERIOR PARA COLUMNA F50-100
External support for F50-100/103 columns

/ Code	4143
/ Pack.	12 /pcs.

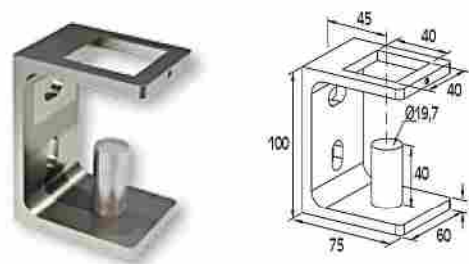

SOPORTE EXTERIOR PARA COLUMNA F50-102
External support for F50-102 column

/ Code	4144
/ Pack.	12 /pcs.



SOPORTE SIMPLE PARA CRISTA 8-10 MM
Single glass support 8-10 mm
for BLADE column

/ Code	4146
/ Pack.	10 /pcs.

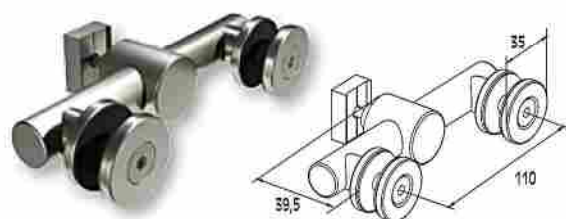

SOPORTE DOBLE PARA CRISTAL 8-10 MM
Double glass support 8-10 mm
for BLADE column

/ Code	4147
/ Pack.	20 /pcs.

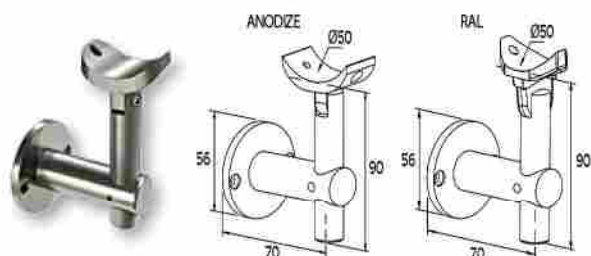

UNIÓN PARED PASAMANOS F50-200
Wall support for F50-200 handrail

/ Code	4165
/ Pack.	20 /pcs.

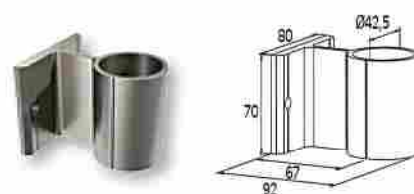

SUJECCIÓN COLUMNA A PARED F50-100
External support for Ø42 column

/ Code	4166
/ Pack.	10 /pcs.

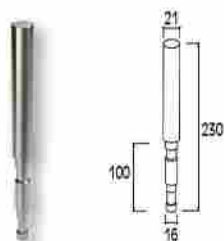

SUJECCIÓN COLUMNA F50-100 & F50-101
AL SUELO
Infloor support for Ø42 columns

/ Code	4167
/ Pack.	25 /pcs.

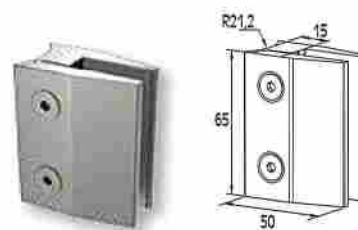

SUJECCIÓN CRISTAL DE 8 A 10MM
Glass support 8-10 mm

/ Code	4168
/ Pack.	50 /pcs.

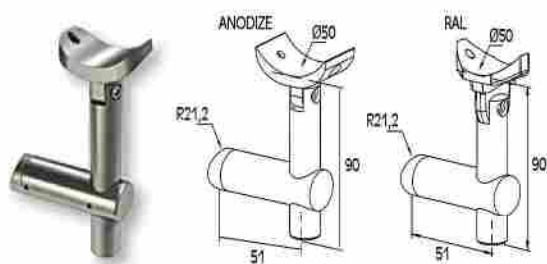

SUJECCIÓN PASAMANOS F-50 COLUMNA
External support for handrail Ø50-column Ø42

/ Code	4169
/ Pack.	10 /pcs.

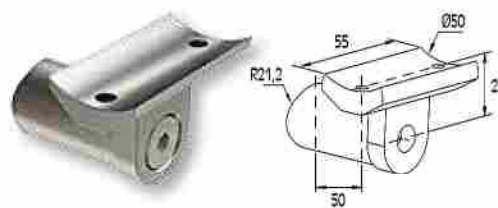

SOPORTE COLUMNA EXTERNO
F50-100 Y F-50-200

External support for handrail Ø50-column Ø42	
/ Code	4169B
/ Pack.	40 /pcs.

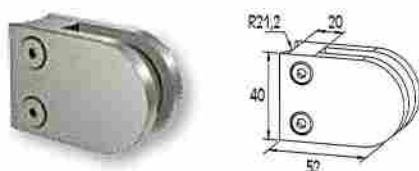

PINZA DE SUJECCION 6-8 MM
INOX Glass support 6-8 mm

/ Code	4172
/ Pack.	40 /pcs.

Available in INOX 304 and INOX 316

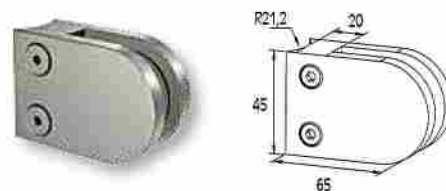

PINZA DE SUJECCION CRISTAL
8-10 MM 45 X 65

INOX Glass support 8-10 mm	
/ Code	4173
/ Pack.	50 /pcs.

Available in INOX 304 and INOX 316

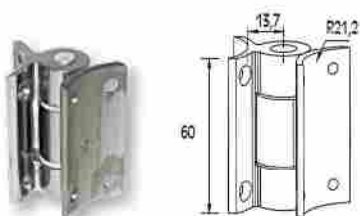

VISAGRA PARA LA COLUMNA F50-100
Hinge for F50-100 column

/ Code	4177
/ Pack.	10 /pcs.



SUJECCIÓN PASAMANOS F50-200
A COLUMNA F50-101

Support for F50-200 handrail- F50-101 column	
/ Code	4179
/ Pack.	20 /pcs.

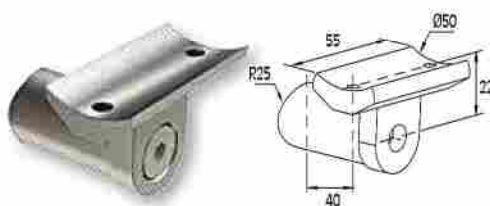

SUJECCIÓN EXTERNA A PASAMANOS
External Support for F50-200
handrail to F50-101 column

/ Code	4180
/ Pack.	40 /pcs.

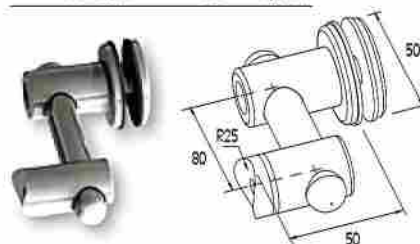

SOPORTE BÁSICO DE CRISTAL
EXTERNO A COLUMNA
Single glass support 8-10 mm
for Ø50 column

/ Code	4181
/ Pack.	10 /pcs.

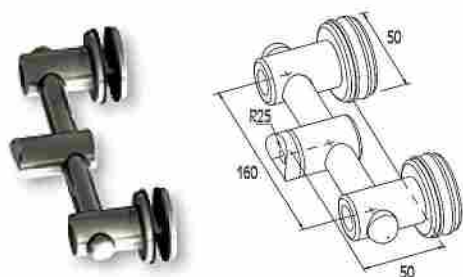

SOPORTE EXTERNO CRISTAL DOBLE DE 8-10 mm
Double glass support 8-10 mm for Ø50 column

/ Code	4182
/ Pack.	20 /pcs.

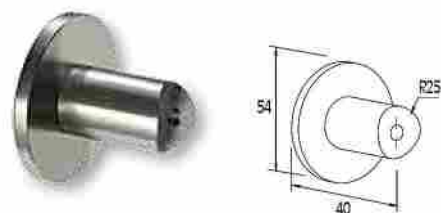

PIE EXTERIOR DE COLUMNA F50-101
External support for F50-101 column

/ Code	4184
/ Pack.	20 /pcs.

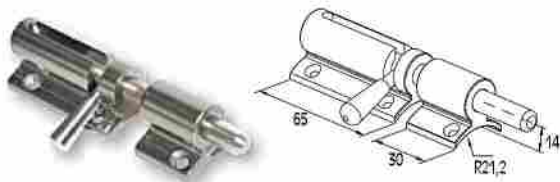

CERROJO PARA LA COLUMNA F50-100
Bolt for F50-100 column

/ Code	4186
/ Pack.	10 /pcs.

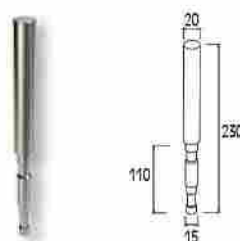

SUJECCIÓN AL SUELO PARA COLUMNA F50-102
Infloor support for F50-102 column

/ Code	4188
/ Pack.	25 /pcs.

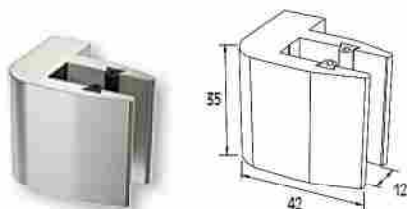

PINZA SENCILLA PARA CRISTAL 8-10mm COLUMNA F50-102
Single glass support 8-10 mm for F50-102 column

/ Code	4189
/ Pack.	20 /pcs.

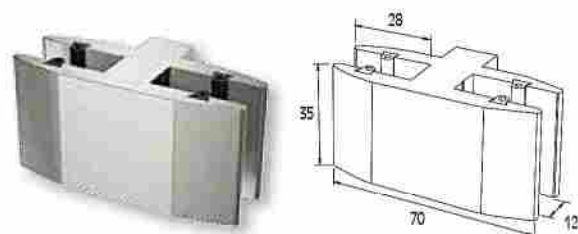

PINZA DOBLE PARA CRISTAL 8-10mm COLUMNA F50-102
Double glass support 8-10 mm for F50-102 column

/ Code	4190
/ Pack.	50 /pcs.

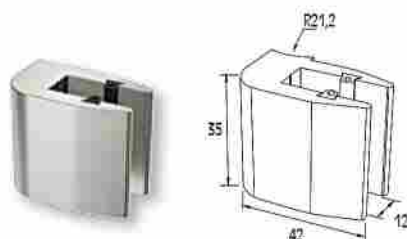

PINZA PARA CRISTAL DE 8-10mm PARA COLUMNA F50-103
Single glass support 8-10 mm for F50-103 column

/ Code	4191
/ Pack.	20 /pcs.

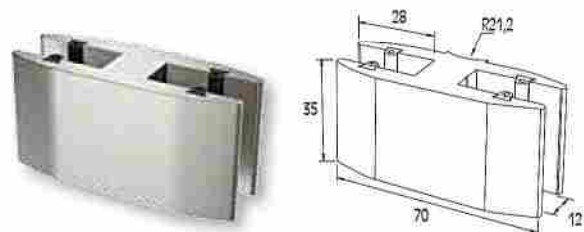

PINZA DOBLE PARA CRISTAL DE 8-10mm PARA COLUMNA F50-103
Double glass support 8-10 mm for F50-103 column

/ Code	4192
/ Pack.	50 /pcs.

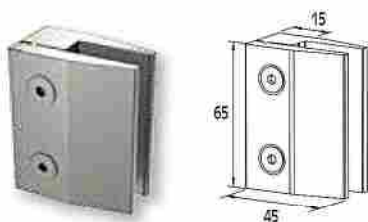

PINZA PLANA PARA CRISTAL 8-10mm
COLUMNA F50-102, F50-106

Single glass support 8-10 mm
for F50-102/106 columns

/ Code **4193**

/ Pack. 50 /pcs.

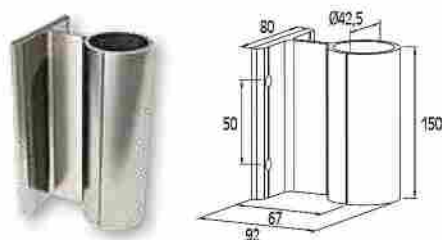

PIE DE SOPORTE EXTERIOR 15 cm
PARA COLUMNA F50-100

External support for column Ø42

/ Code **4194**

/ Pack. 20 /pcs.

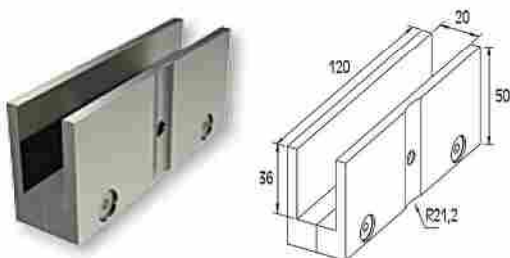

SOPORTE DOBLE CRISTAL 19-22MM
PARA COLUMNA DE 42

Double glass support 19-22 mm

/ Code **4195**

/ Pack. 10 /pcs.



UNIÓN PASAMANOS

Connector for handrail Ø50

/ Code **4218**

/ Pack. 20 /pcs.

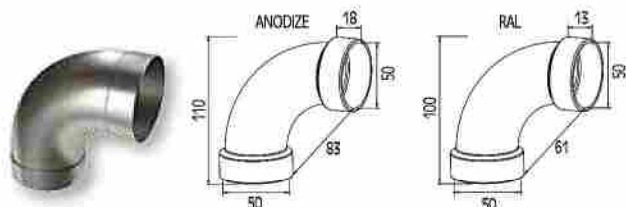

UNIÓN ESQUINA PASAMANOS 90°
Connector 90° for handrail Ø50

/ Code **4219**

/ Pack. 20 /pcs.

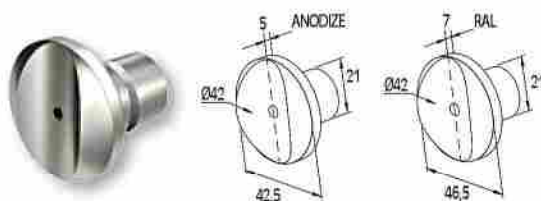

UNIÓN COLUMNA F50-100 HORIZONTAL

Connector for column
with column F50-100

/ Code **4224**

/ Pack. 50 /pcs.

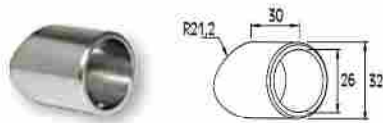

UNIÓN ENTRE COLUMNA F50-100 Y PERFIL F26

Connector for F50-100 column
with profile Ø26

/ Code **4225**

/ Pack. 50 /pcs.

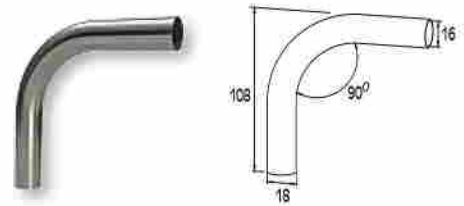

VARILLA CONECTORÁ F16 EN 90°
Connector 90° for profile Ø16

/ Code **4228**

Συσκ. / Pack. 40 /pcs.

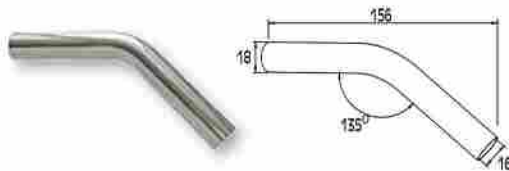

VARILLA CONECTORÁ F16 EN 90°
Connector 135° for profile Ø16

/ Code **4229**

/ Pack. 40 /pcs.

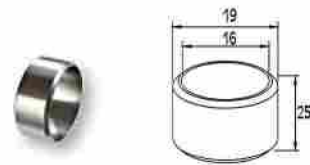

UNION VARILLA CON VARILLA DE F16
Connector for profile Ø16 (straight)

/ Code **4230**

/ Pack. 100 /pcs.

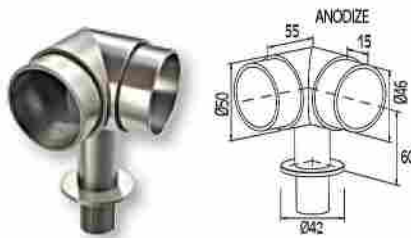

UNIÓN PASAMANOS EN 90°
Ø50 Railtop corner
Connector 90° for handrail Ø50

/ Code **4231**

/ Pack. 15 /pcs.

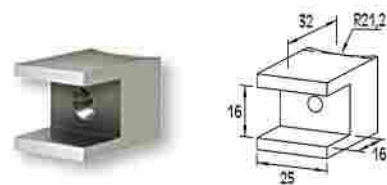

UNIÓN COLUMNA F50-100 CON PERFIL
F50-302 (SUJECION EXTERIOR)

Connector for F50-100 Column
with F50-302 profile

/ Code **4232**

/ Pack. 100 /pcs.

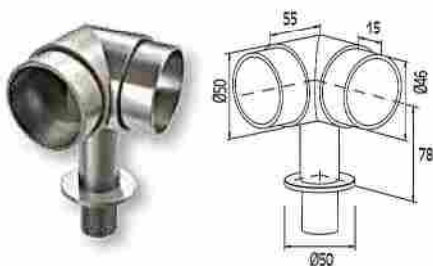

ARTICULACIÓN DE PASAMANOS EN 90° PARA F50-101

Connector 90° for handrail Ø50

/ Code **4235**

/ Pack. 15 /pcs.

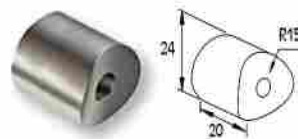

UNIÓN DE COLUMNA CON RAIL
F50-307 CON F50-102

Connector for F50-307 guide
with F50-102 column

/ Code **4240**

/ Pack. 20 /pcs.

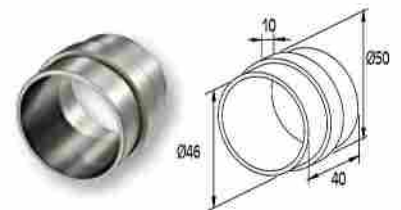

UNIÓN DE PASAMANOS CON PASAMANOS (INTERIOR)

Connector for handrail Ø50 (internal)

/ Code **4241**

/ Pack. 20 /pcs.

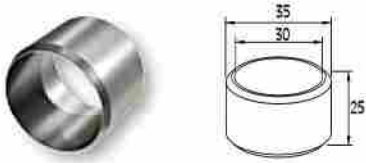

UNIÓN DE RAIL A RAIL
 Connector for guide Ø30 (straight)

/ Code	4242
/ Pack.	20 /pcs.

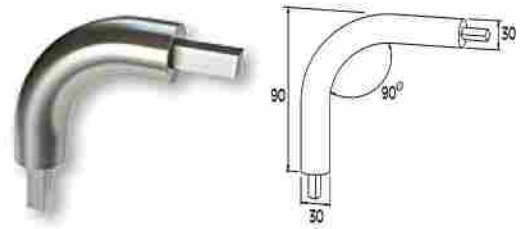

UNIÓN ENTRE RAILES EN 90º
 Connector 90° for F50-307 guide

/ Code	4243
/ Pack.	10 /pcs.

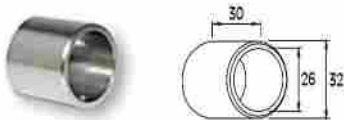

UNION EXTERNA DEL PERFIL F50-102/106 CON F26
 Connector for F50-102/106 Column with profile Ø26

/ Code	4244
/ Pack.	50 /pcs.

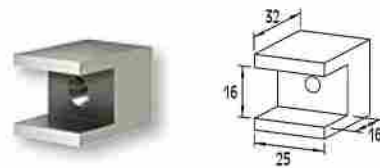

UNION EXTERNA DEL PERFIL F50-102/106 Y PERFIL F50-302
 Connector for F50-102/106 Column with F50-302 profile

/ Code	4245
/ Pack.	100 /pcs.

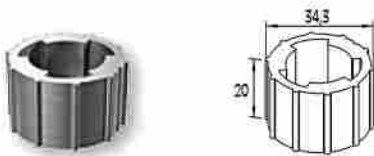

ROSETA 20 MM PARA COLUMNA F50-104 COLOR BRUTO
 Adaptor for F50-104 Column

/ Code	4248
/ Pack.	50 /pcs.

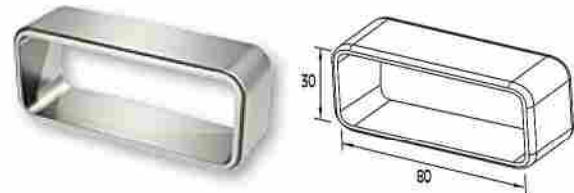

UNION DE PASAMANOS 80 x 30mm
 Connector for 80x30 handrails straight

/ Code	4249
/ Pack.	20 /pcs.

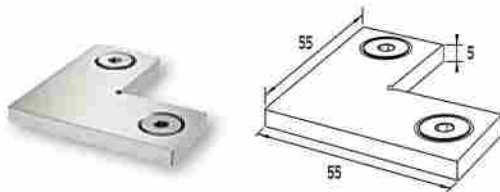

UNION DE PASAMANOS EN 90º PARA F50-201
 Connector 90° for F50-201 handrail

/ Code	4250
/ Pack.	50 /pcs.

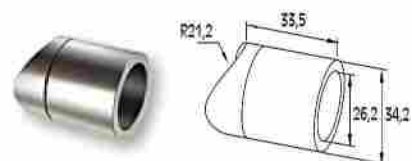

UNIÓN F50-100 CON PERFIL 26 MM
 Connector for F50-100 Column with profile Ø26

/ Code	4252
/ Pack.	50 /pcs.



CONECTOR DE PASAMANOS A 90°
Connector 90° for handrail Ø50

/ Code	4256
/ Pack.	15 /pcs.

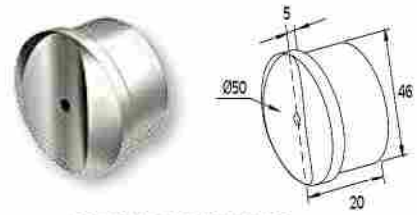

CONECTOR DE PASAMANOS F50-200 (CONECTOR VERTICAL)
Connector for handrail with handrail F50-200

/ Code	4257
/ Pack.	50 /pcs.

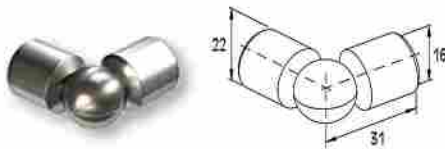

ARTICULACIÓN REGULABLE PARA RAIL F-16
Adjustable angle connector for profile Ø16

/ Code	4302
/ Pack.	50 /pcs.

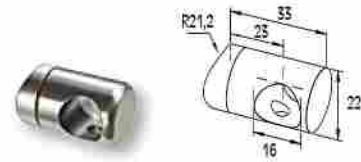

UNIÓN COLUMNA F50-100 PARA PERFIL F16
Connector for F50-100 column with guide Ø16

/ Code	4312
/ Pack.	12 /pcs.



SUJECCIÓN PILAR A PASAMANOS EN RECTO EN INOX
Connector for handrail Ø50 with column Ø42

/ Code	4314
/ Pack.	50 /pcs.

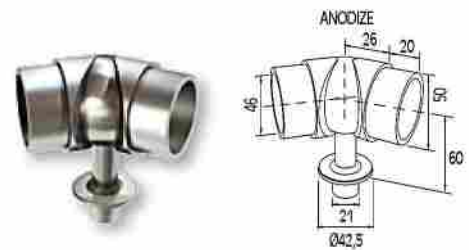

ARTICULACION ESQUINA F-50
Adjustable corner Ø50 railtop connector

/ Code	4319
/ Pack.	15 /pcs.



SUJECCIÓN PASAMANOS F-50 A COLUMNA F50-100 (ESCALERA)
Connector for handrail Ø50 with column Ø42 (stairs)

/ Code	4316
/ Pack.	40 /pcs.

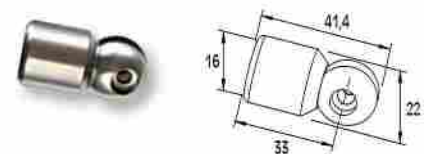

UNIÓN ROSETA CRISTAL CON F-16
Connector for glass rosette with profile Ø16

/ Code	4322
/ Pack.	40 /pcs.

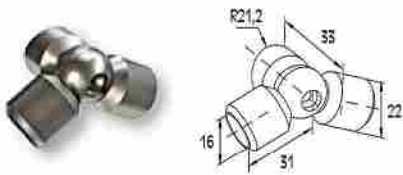

ARTICULACIÓN ESQUINA F-16 UNIÓN
CON COLUMNA F50-100
Adjustable corner connector for profile
Ø16 with F50-100 column

/ Code	4323
/ Pack.	20 /pcs.



UNION EN HORIZONTAL DE PERFIL
F16 A COLUMNA F50-100
Connector 90° for profile Ø16 with
F50-100 column

/ Code	4324
/ Pack.	20 /pcs.

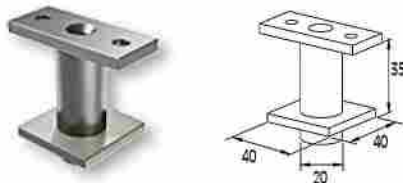

UNIÓN COLUMNA CON PASAMANOS F50-201
Support for F50-102 column
with F50-201 handrail

/ Code	4328
/ Pack.	40 /pcs.



ARTICULACION ESQUINA F-50 PASAMANOS SIN AGUJERO
Adjustable corner connector
for column Ø50

/ Code	4329
/ Pack.	15 /pcs.

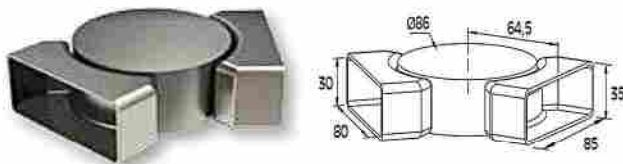

UNIÓN EN ESQUINA DE PASAMANOS F50-201, F50-203
Adjustable corner connector
for F50-201/203 railtop

/ Code	4332
/ Pack.	10 /pcs.

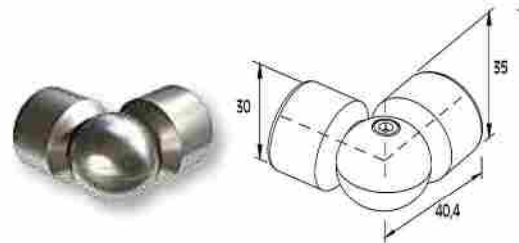

ARTICULACION PARA PASAMANOS EN ESQUINA F50-307
Adjustable corner connector
for F50-307 guide

/ Code	4333
/ Pack.	20 /pcs.

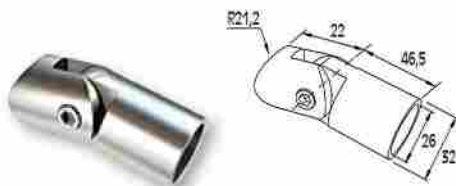

ARTICULACION COLUMNA F50-100 CON PERFIL F26
Connector for F50-100 column with profile Ø26

/ Code	4335
/ Pack.	40 /pcs.



UNION F50-100 CON F50-201.
Connector for F50-100 column
with F50-201 handrail

/ Code	4337
/ Pack.	40 /pcs.

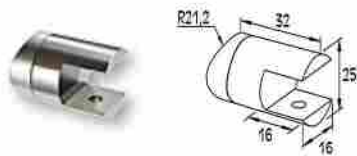

UNION COLUMNA F50-100
CON PERFIL F50-302 (16 x 16)
Connector for F50-100 Column
with F50-302 profile

/ Code	4341
/ Pack.	50 /pcs.

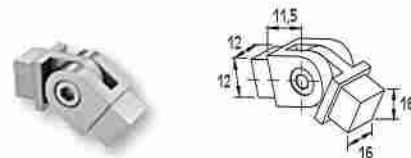

UNION EN ESQUINA DE RAIL F50-302 (16 x 16)
Adjustable corner connector
for F50-302 profile

/ Code	4342
/ Pack.	50 /pcs.

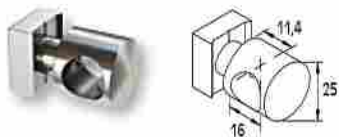

UNION DE COLUMNA 4620 PARA F-16
Connector for profile Ø16 with BLADE column

/ Code	4343
/ Pack.	50 /pcs.

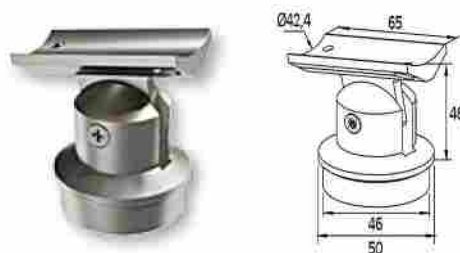

UNIÓN F50-103 CON F50-200 (ESCALERA)
Connector for F50-100 column
with F50-200 handrail

/ Code	4344
/ Pack.	50 /pcs.

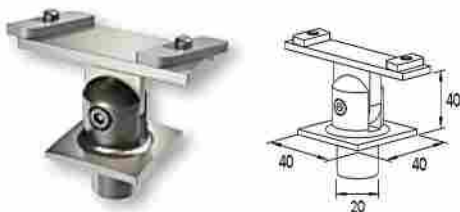

UNION DE COLUMNA 4620 PARA F-16
Connector for F50-102 column
with F50-201 handrail

/ Code	4345
/ Pack.	40 /pcs.

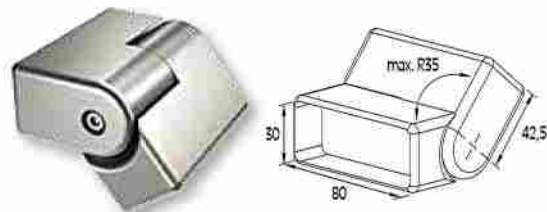

CONECTOR PARA PASAMANOS DE 80 X 30
Adjustable corner connector
for 80x30 handrail (stairs)

/ Code	4346
/ Pack.	15 /pcs.

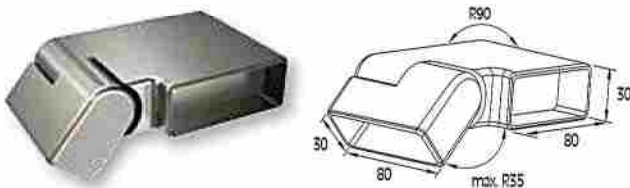

CONECTOR PARA PASAMANOS DE 80 X 30
Adjustable corner connector 90°
for 80x30 handrail (stairs)

/ Code	4347
/ Pack.	10 /pcs.

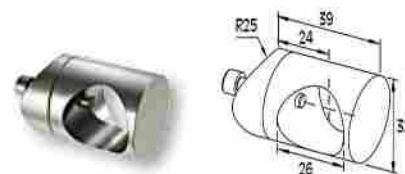

CONECTOR COLUMNA F50-101
PARA PERFIL DE 26MM
Connector for F50-101 column with profile Ø26

/ Code	4348
/ Pack.	50 /pcs.

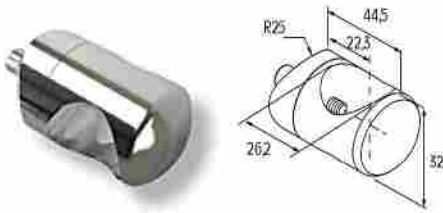

CONECTOR COLUMNA F50-101
PARA PERFIL DE 26MM
 Connector for F50-101 column with profile Ø26

/ Code	4348B
/ Pack.	50 /pcs.

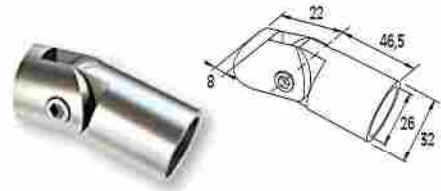

UNIÓN DE F50-102 CON PERFIL DE 26 MM
 Connector for F50-102 column with profile Ø26

/ Code	4349
/ Pack.	20 /pcs.

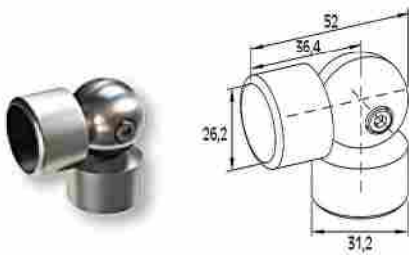

PERFIL CONECTOR DE 26MM
 Adjustable corner connector for profile Ø26

/ Code	4352
/ Pack.	20 /pcs.

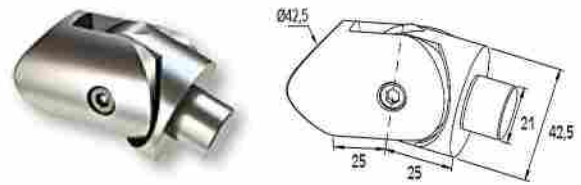

CONECTOR F50-100 EN ESCALERA
 Connector for column with column
 F50-100 (stairs)

/ Code	4355
/ Pack.	30 /pcs.

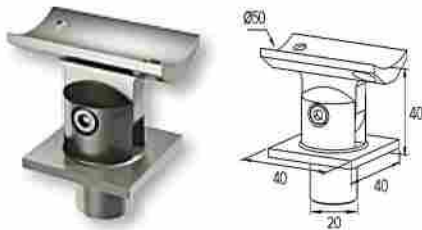

UNIÓN DE PASAMANOS A COLUMNA F50-102
 Support for F50-200 handrail-
 F50-102 column (stairs)

/ Code	4356
/ Pack.	50 /pcs.

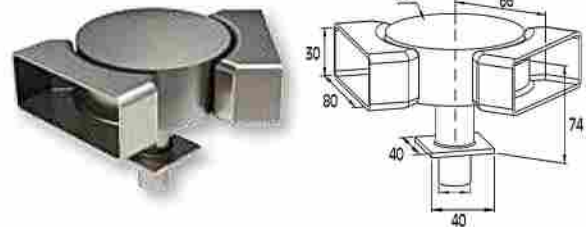

UNIÓN EN ESQUINA DE 80 X 30
DE PASAMANOS A COLUMNA
 Adjustable corner connector for
 80x30 handrail with F50-102 column

/ Code	4357
/ Pack.	2 /pcs.

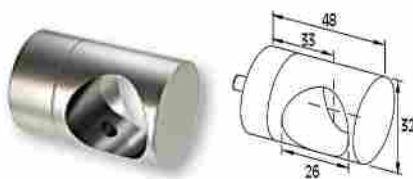

CONECTOR A COLUMNA F50-102
 Connector for F50-102 column
 with profile Ø26

/ Code	4358
/ Pack.	50 /pcs.

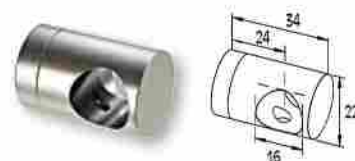

CONECTOR DE 16 A COLUMNA F50-102
 Connector for F50-102 column
 with profile Ø16

/ Code	4359
/ Pack.	50 /pcs.

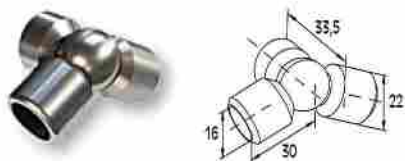

UNIÓN EN ESQUINA DE PERFIL DE 16 A COLUMNA F50-102
Adjustable corner connector for profile Ø16

/ Code	4360
/ Pack.	20 /pcs.

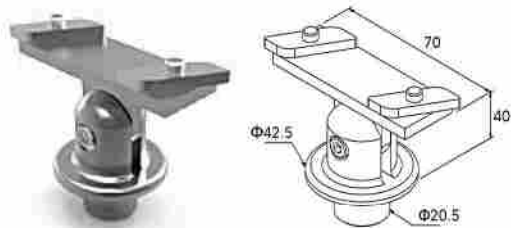

UNIÓN PASAMANOS F50-201 A F50-100
Support for F50-201 handrail-F50-100 column (stairs)

/ Code	4361
/ Pack.	20 /pcs.

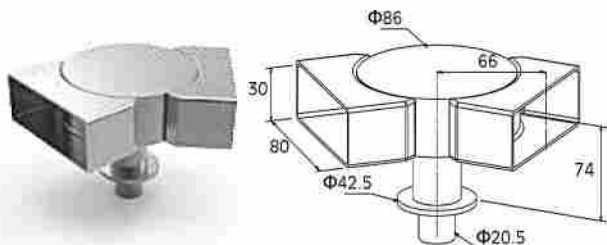

UNIÓN EN ESQUINA F50-201 CON F50-100
Adjustable corner connector for handrail 80x30 with column Ø42

/ Code	4373
/ Pack.	20 /pcs.

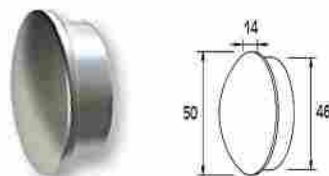

TAPA PASAMANOS F50-200
End cap for F50-200 handrail

/ Code	4434
/ Pack.	50 /pcs.

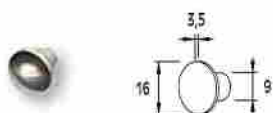

TAPA PERFIL F50-301 (F-16 x 35mm)
End cap for F50-301 profile

/ Code	4435
/ Pack.	100 /pcs.

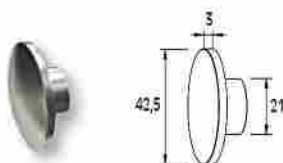

TAPA COLUMNA F50-100
End cap for F50-100 column

/ Code	4436
/ Pack.	50 /pcs.

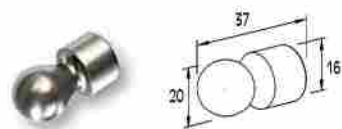

DECORACIÓN FINAL PARA ESCALERA F-16
End cover for profile Ø16

/ Code	4437
/ Pack.	50 /pcs.

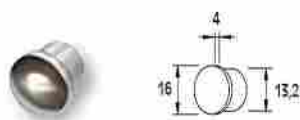

TAPA PERFIL F50-300 (F-16 X 13mm)
End cap for F50-300 profile

/ Code	4438
/ Pack.	50 /pcs.

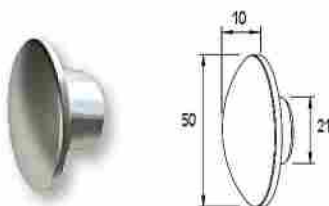

TAPA COLUMNA F50-101
End cap for F50-101 column

/ Code	4443
/ Pack.	20 /pcs.

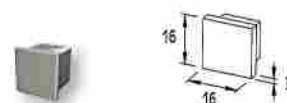

TAPA RAIL F50-302 (16 X 16)
End cap for F50-302 profile

/ Code	4444
/ Pack.	50 /pcs.

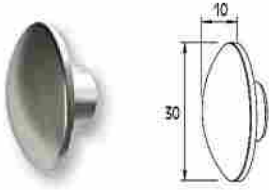

TAPA RAIL F50-307
End cap for F50-307 guide

/ Code	4446
/ Pack.	50 /pcs.

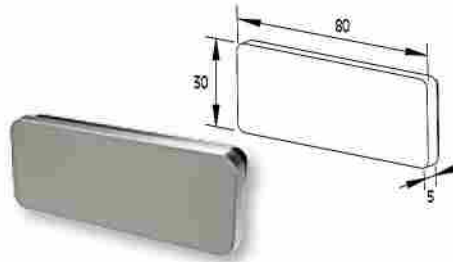

TAPA DE PASAMANOS F50-201
End cap for F50-201 handrail

/ Code	4447
/ Pack.	20 /pcs.

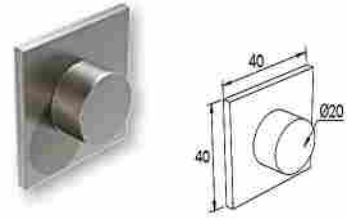

TAPA COLUMNA F50-102
End cap for F50-102 column

/ Code	4448
/ Pack.	40 /pcs.

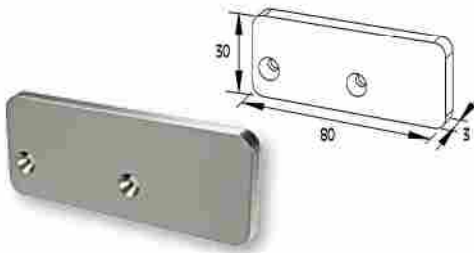

TAPA PASAMANOS F50-203
End cap for F50-203 handrail

/ Code	4451
/ Pack.	10 /pair

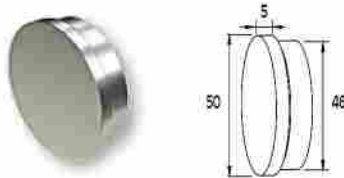

TAPA PASAMANOS F50-200
End cap for F50-200 handrail (flat)

/ Code	4453
/ Pack.	50 /pcs.

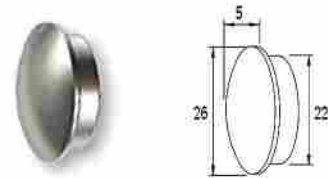

TAPA PERFIL F50-304
End cap for F50-304 profile

/ Code	4461
/ Pack.	50 /pcs.

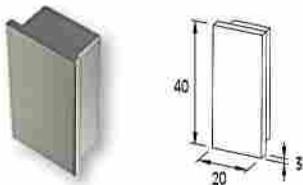

TAPA PERFIL ALUMINIO 40x20 MM 59-009
End cap for 59-009 profile

/ Code	4464
/ Pack.	50 /pcs.

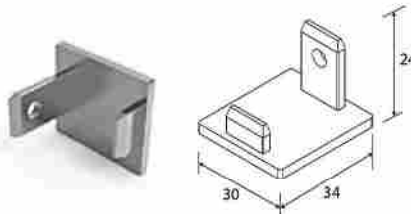

TAPA RAIL F50-319
End cap for F50-319 guide

/ Code	4477
/ Pack.	40 /pcs.

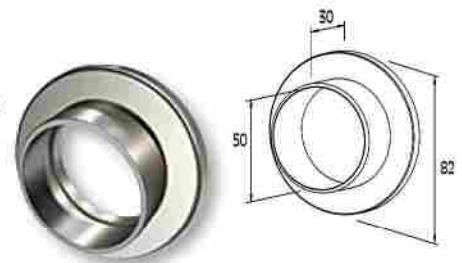

PIEZA Y EMBELLECEDOR PASAMANOS
Wall cover for handrail Ø50 with cap

/ Code	4509Z
/ Pack.	20 /pcs.

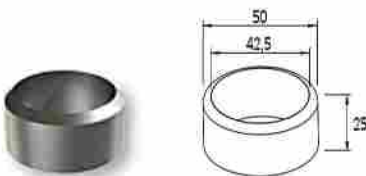

EMBELLECEDOR COLUMNA F50-100
Wall cover for column Ø42

/ Code	4510
/ Pack.	50 /pcs.



EMBELLECEDOR PARA COLUMNA F50-101
Wall cover for F50-101 column

/ Code	4513
/ Pack.	40 /pcs.

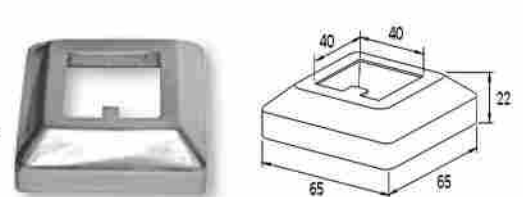

EMBELLECEDOR DE COLUMNA F50-102
Wall cover for F50-102 column

/ Code	4514
/ Pack.	50 /pcs.

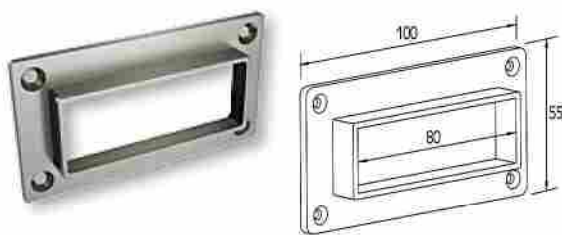

UNION PASAMANO A PARED F50-201, F50-203
Wall cover for F50-201/203 handrail

/ Code	4515
/ Pack.	40 /pcs.

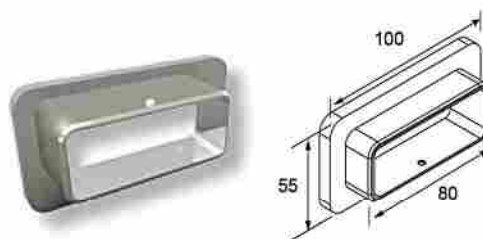

TAPA UNIÓN PARED
Wall cover for F50-201/203 handrail (with cap)

/ Code	4515Z
/ Pack.	40 /pcs.

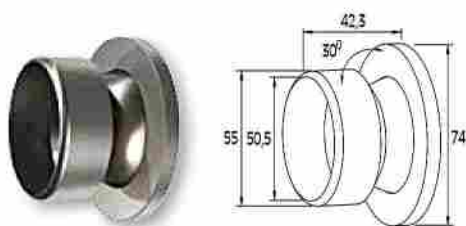

UNIÓN DE PASAMANOS PARED REGULABLE
Wall cover for handrail Ø50 with cap

/ Code	4518
/ Pack.	20 /pcs.

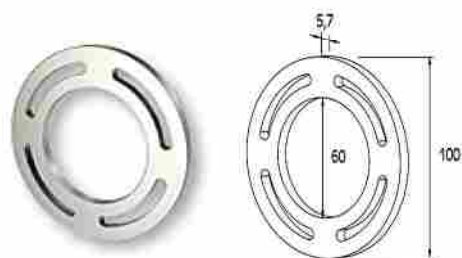

ROSETA DECORATIVA CRISTAL
Glass rosette Ø100

/ Code	4611
/ Pack.	20 /pcs.

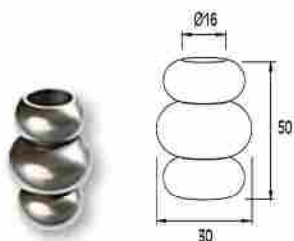

DECORACIÓN PERFIL PARA ESCALERA F-16
Glass rosette for profile Ø16

/ Code	4618
/ Pack.	50 /pcs.

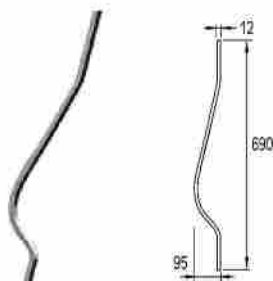

PERFIL CURVADO PARA VERTICAL-D
Curved profile for Vertical-D

/ Code	4670
/ Pack.	100 /pcs.

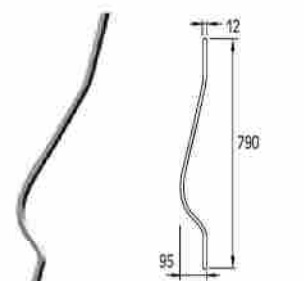

PERFIL CURVADO PARA VERTICAL-D
Curved profile for Vertical-D

/ Code	4680
/ Pack.	100 /pcs.

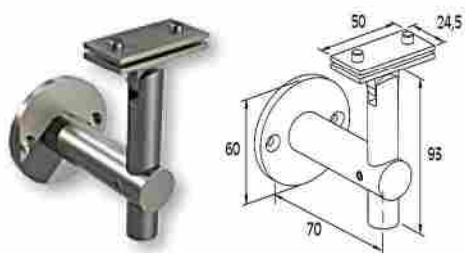

DECORACIÓN PERFIL PARA ESCALERA F-16
F50-201 Railtop wall support

/ Code	F85-452
/ Pack.	40 /pcs.



GOMAS PARA 12MM DE CRISTAL
F50-319/203 rail gasket for 12 mm glass

/ Code	US530-3PRM
/ Pack.	10 Kgr

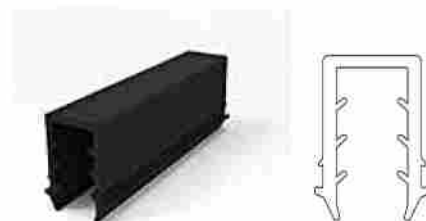

GOMA CON FORMA DE U PARA 10.76 DE CRISTAL
"U" shape gasket for 10.76 mm glass (5 mm-2PVB-5 mm)

/ Code	4910
/ Pack.	40 m

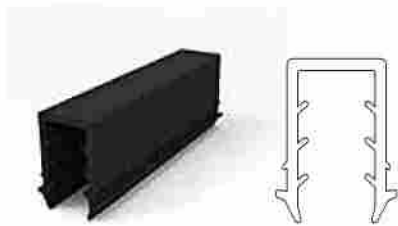

ACCESORIO DE GOMA PARA CRISTAL DE 11.52MM
"U" shape gasket for 11.52 mm glass (5 mm-4PVB-5 mm) up to 12 mm glass

/ Code	4911
/ Pack.	40 m

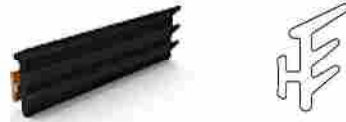

GOMA PARA RAIL F50-319 PARA CRISTAL 10MM

Gasket for F50-319 guide
(10 mm glass)

/ Code	4912
/ Pack.	280 m

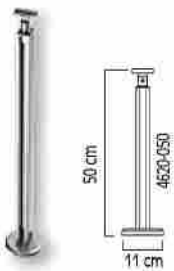

COLUMNA ACABADA (ALTURA 50cm)
Ready made column Height 50 cm

/ Code	4620-050
/ Pack.	1 /pcs.

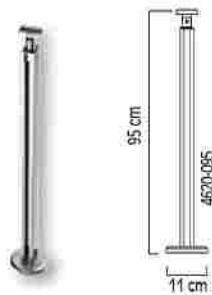

COLUMNA ACABADA (ALTURA 95cm)
Ready made column Height 95 cm

/ Code	4620-095
/ Pack.	1 /pcs.

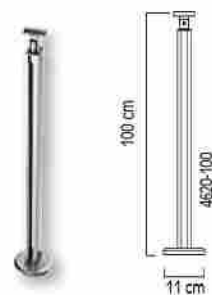

COLUMNA ACABADA (ALTURA 100cm)
Ready made column Height 100 cm

/ Code	4620-100
/ Pack.	1 /pcs.

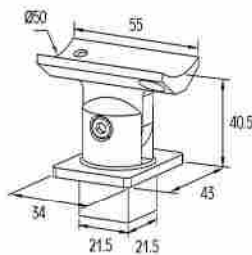

UNION COLUMNA CON PASAMANOS F50-200
F50-200 Railtop support stairs

/ Code	4620-310
/ Pack.	50 /pcs.

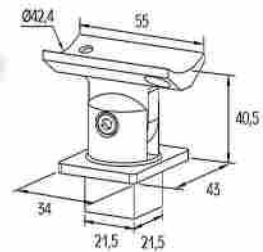

UNION COLUMNA CON PASAMANOS DE 42MM
Ø42 Railtop support stairs

/ Code	4620-311
/ Pack.	50 /pcs.

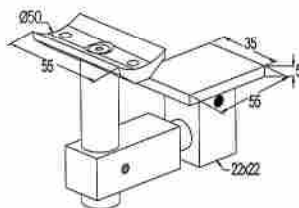

SOPORTE PARA Ø50 Y PILAR DE 40 X 40
Ø50 Railtop support stairs

/ Code	4620-312
/ Pack.	50 /pcs.

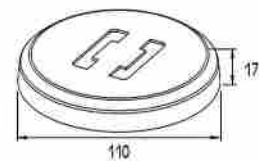

PIE PARA COLUMNA F50-108
F50-108 Column support foot

/ Code	4620-320
/ Pack.	50 /pcs.

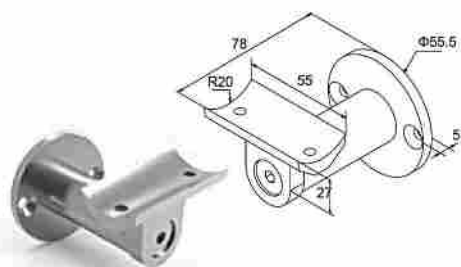

SOPORTE DE PARED A PASAMANOS DE 40MM

Wall support for Ø40 handrail			
/ Code	4135		
/ Pack.	20	/pcs.	



UNION PASAMANOS DE 40MM

Connector for handrail Ø40 mm			
/ Code	4260		
/ Pack.	20	/pcs.	

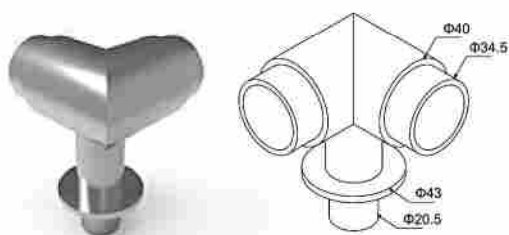

CONECTOR DE PASAMANOS DE 40MM

Connector 90° for handrail Ø40			
/ Code	4262		
/ Pack.	15	/pcs.	

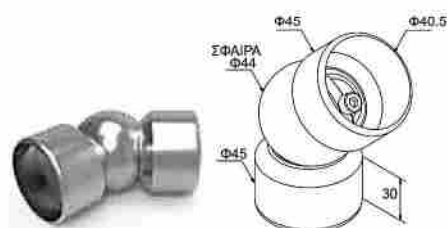

CONECTOR PARA PASAMANOS DE 40MM

Adjustable corner connector for handrail Ø40			
/ Code	4367		
/ Pack.	15	/pcs.	

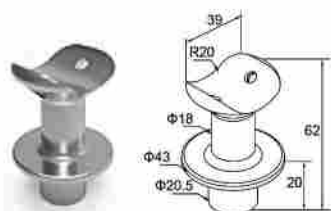

Support for handrail Ø40-column Ø42 (stairs)

/ Code	4368		
/ Pack.	50	/pcs.	

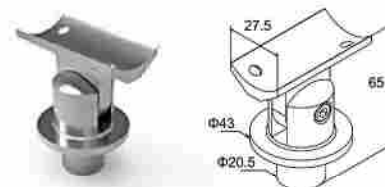

UNION PASAMANOS A COLUMNA DE 42MM

Adjustable corner support for handrail Ø40 - column Ø42			
/ Code	4369		
/ Pack.	50	/pcs.	

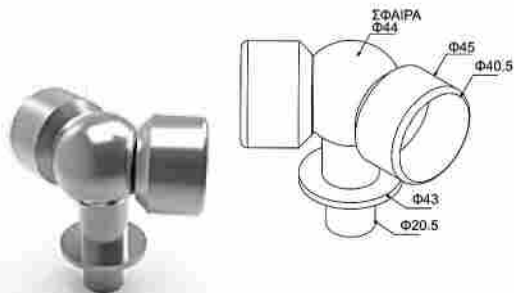

UNION DE PASAMANOS EN ESQUINA

Adjustable corner connector for handrail Ø40 with column Ø42			
/ Code	4370		
/ Pack.	15	/pcs.	

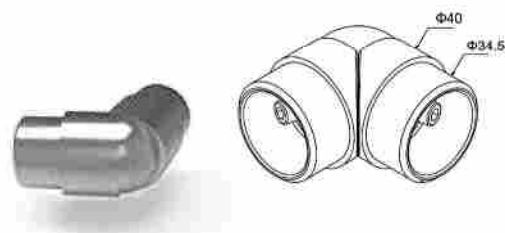

CONECTOR PARA PASAMANOS EN ESQUINA

Adjustable corner connector for handrail Ø40			
/ Code	4371		
/ Pack.	15	/pcs.	

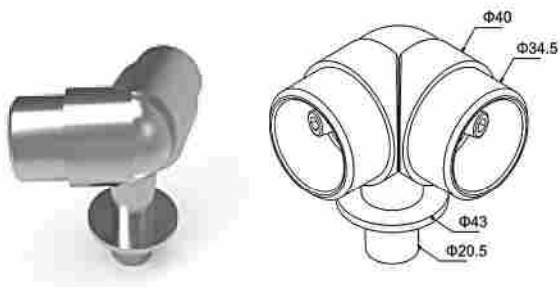

CONECTOR FLEXIBLE PARA PASAMNOS DE 40MM
Adjustable corner connector for handrail
Ø40 with column Ø42

/ Code	4372
/ Pack.	15 /pcs.

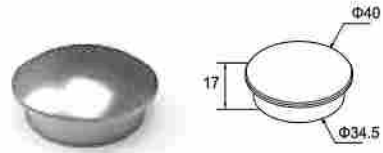

TAPA PARA PASAMANOS DE 40MM
End cap for handrail Ø40

/ Code	4479
/ Pack.	50 /pcs.

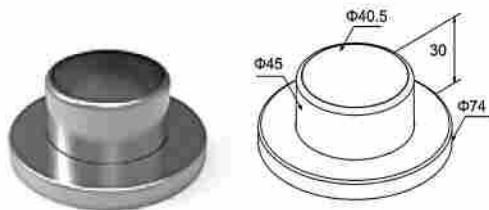

SOPORTE PARA COLUMNA REDONDA DE 40MM
Wall cover for handrail Ø40

/ Code	4520Z
/ Pack.	20 /pcs.

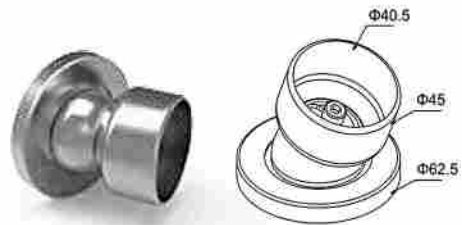

SUJECION DE PASAMANOS 40MM
A PARED PARA ESCALERA
Wall cover for handrail Ø40 with cap

/ Code	4521
/ Pack.	20 /pcs.

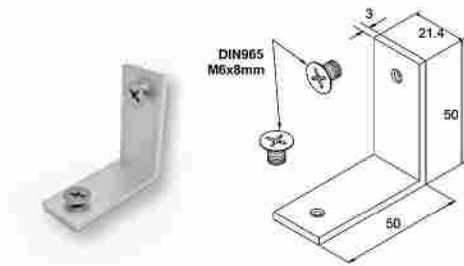

CONECTOR PARA LA GUIA F50-319
Connector for F50-319 guide
 / Code **4259**
 / Pack. 50 /pcs.

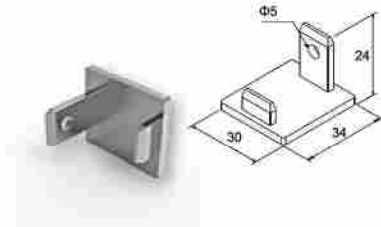

TAPA RAIL F50-319
End cap for F50-319 guide
 / Code **4477**
 / Pack. 50 /pcs.

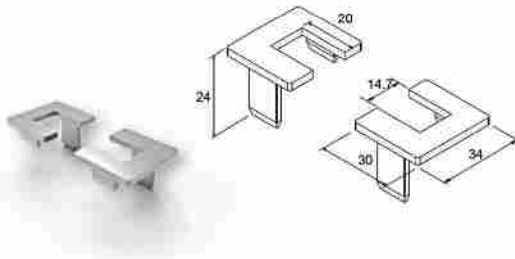

TAPA FINAL PERFIL F50-319 (PAR)
End cap for F50-319 guide (perforated)
 / Code **4478**
 / Pack. 50 /pairs

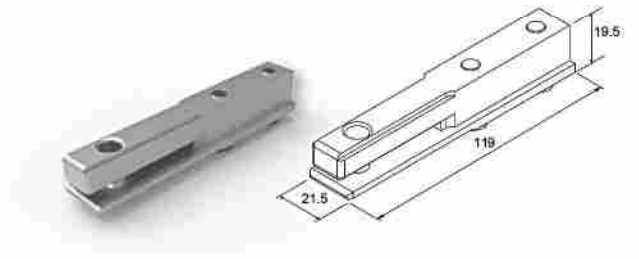

CALIBRE DE LOS AGUJEROS PARA F50-319
Holes calibre for F50-319
 / Code **4971**
 / Pack. 1 /pc.

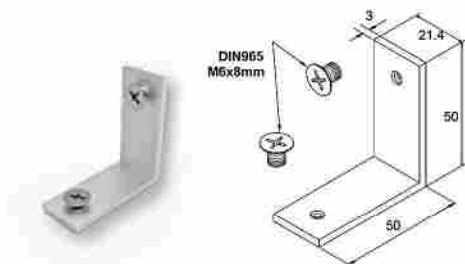

CONECTOR PARA LA GUIA F50-319
Connector for F50-319 guide
 / Code **4259**
 / Pack. 50 /pcs.

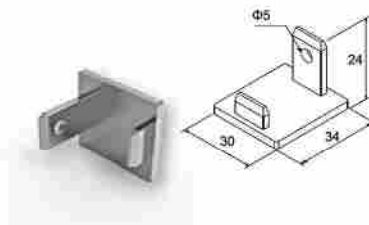

TAPA RAIL F50-319
End cap for F50-319 guide
 / Code **4477**
 / Pack. 50 /pcs.

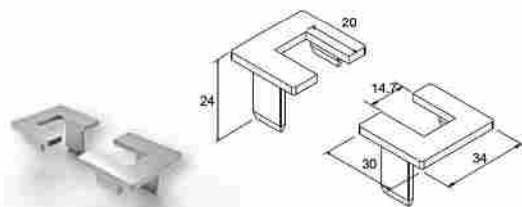

TAPA FINAL PERFIL F50-319 (PAR)
End cap for F50-319 guide (perforated)
 / Code **4478**
 / Pack. 50 /pairs

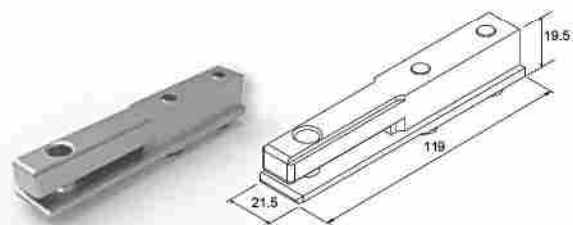

CALIBRE DE LOS AGUJEROS PARA F50-319
Holes calibre for F50-319
 / Code **4971**
 / Pack. 1 /pc.

Lexan® Solid Polycarbonate Sheets



NOTE:

Printed colors are indicative and do not represent 100% the material's actual color and clarity. You are kindly requested to ask for color samples.

TRANSPARENTE / Transparent	
/ Code	PC200-005CL
/ Thickness	5 mm
/ Dim.	205x605 cm

OPACO / Opal	
/ Code	PC200-005OP
/ Thickness	5 mm
/ Dim.	205x605 cm



-EN PROPORCIONES 1:1
 -TIEMPO DE TRABAJO 7-8 MIN
 -INICIACIÓN DEL PEGADO DE 15-18 MIN
 -TIEMPO DE PEGADO DE 3-6 HORAS

- In proportion 1:1
- Working time 7-8 min
- Initial welding time 15-18 min
- Complete welding time 3-6 hours

PEGAMENTO 50 ML Glue 50 ml	
/ Code	6K9450



MEZCLADOR DE PEGAMENTO (ACCESORIO) Glue mixer accessory	
/ Code	6KA100



- Working time 15-20 minutes

RESINA PARA EL INTERIOR DE LOS ACCESORIOS

Resin for infloor supporting accessories	
/ Code	UA320-1EL



MEZCLADOR DE RESINA (ACCESORIO) Resin mixer accessory	
/ Code	6KA102



PISTOLA PARA APLICAR EL PEGAMENTO Glue application pistol	
/ Code	6KA200

*Aluminco no sé responsabiliza de cualquier error técnico, de impresión o de ortografía que pueda ocurrir.

TODOS UN MUNDO DE ALUMINIO QUE TE SORPRENDERÁ ...



WWW.ALUMINCO.ES

ALUMINCO & PANEL,S.L
C/ARROYO DEL CULEBRO,S/N
POL.IND.LAS ARENAS DE PINTO
28320.MADRID.ESPAÑA
TLF:91.692.68.50
EMAIL:info@aluminco-panel.es