

ALUMINCO

CATÁLOGO GENERAL 2011/2012

BALCONES • ESCALERAS • CANCELAS • VALLAS • DECORACIÓN DE JARDINES • PUERTAS DE PANEL

WWW.ALUMINCO.ES



SISTEMAS DE ALUMINO F 50



ALUMINIUM SYSTEM



Índice

		Página
	F50 ALUMINIO INOX SISTEMAS Y ACCESORIOS	4 - 25
	CRYSTALINE SISTEMAS Y ACCESORIOS	26 - 33
	SISTEMA SAZA	34 - 43
	SISTEMA ALFLEX	44 - 52
	SISTEMA F16 F-26	53 - 55
	PUERTAS DE JARDIN - CANCELAS	56 - 59
	CENEFAS Y FLECHAS	60 - 61
	VALLAS CLASICAS - MODERNAS	62 - 63



Página

64 - 67

PERGOLAS Y TECHADOS

68 - 69

COLUMNAS DECORATIVAS Y
DECORACION DE PORCHES

70 - 71

FAROLAS

72 - 73

MUEBLES JARDÍN

74 - 75

REJAS

76 - 79

PANELES

80 - 83

KIT DE MONTAJE SAZA Y ALFLEX

84 - 86

ACCESORIOS Y PERFILES GENERAL

F-50 *Accord*

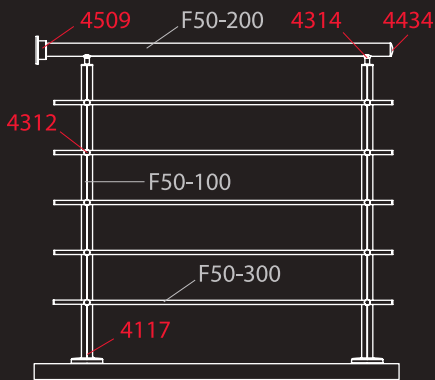

Sistema de barandilla **Aluminio INOX**

4112

PIE DE SUJECIÓN PARA COLUMNA F50-100



4312

UNIÓN COLUMNA HORIZONTAL PERFIL F-16



4121

PIE DE SUJECIÓN PARA COLUMNA F50-100



4314

SUJECIÓN PASAMANOS F-50 - COLUMNA



4219

UNIÓN ESQUINA PASAMANOS

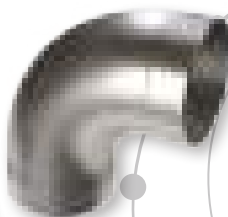

4319

ARTICULACIÓN ESQUINA F-50



4437

DECORACIÓN FINAL PARA ESCALERA F-16



4228

UNIÓN EN 90° GRADOS A PERFIL F16

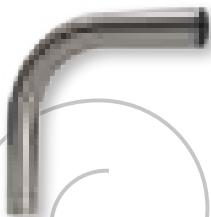

4229

UNIÓN EN 135° GRADOS A F16



F50-100

COLUMNA SUJECIÓN PERÍMETRO 42 MM

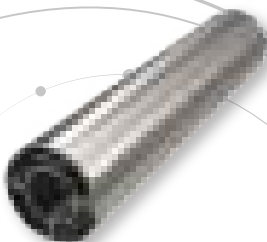

4116

SOPORTE PASAMANOS F50-200



F50-200

PASAMANOS F-50 50 MM



4165

UNIÓN PARED PASAMANOS F50-200



F50-300

RAIL CIRCULAR DE 16 X 2 MM, PERFIL FT6XT,3MM

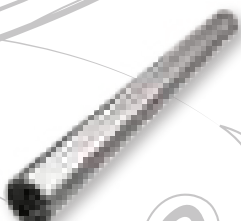

4316

SUJECIÓN PASAMANOS F-50 ACOLUMNA F50

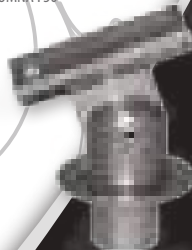

4329

ARTICULACIÓN ESQUINA F-50 SIN AGUJERO



F-50 Accord

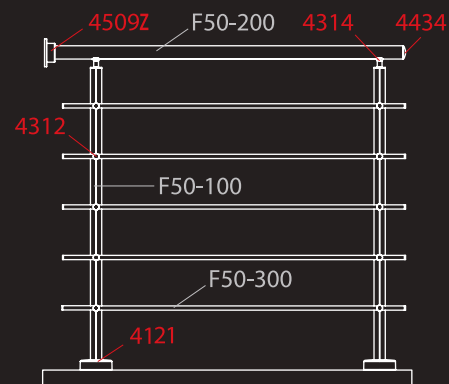

F-50 *Accord* Quattro

Sistema de barandilla **Aluminio INOX**

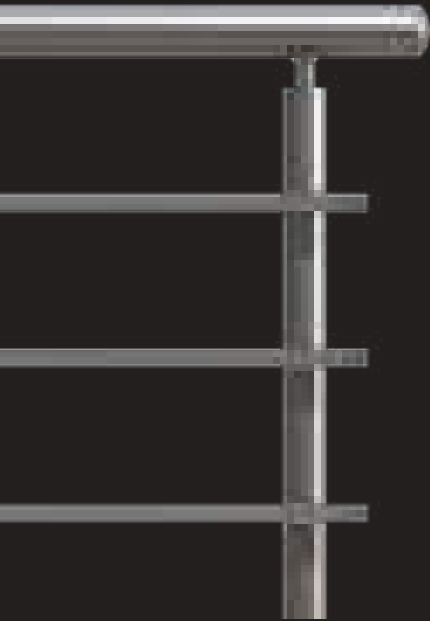

4231

ARTICULACIÓN DE PASAMANOS EN 90º GRADOS



4444

TAPA RAIL F50-302 16 X 16

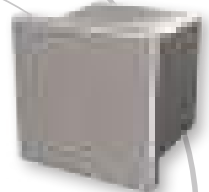

4232

UNIÓN COLUMNA F50-100 CON PERFIL F50-302

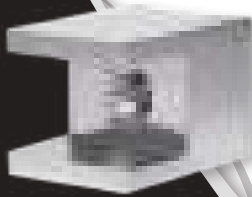

4509Z

EMBELLECEDOR PASAMANOS F-50

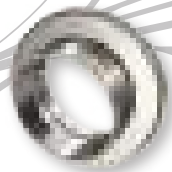

4314

SUJECIÓN PASAMANOS F-50 A COLUMNA



4447

TAPA DE PASAMANOS F50-201

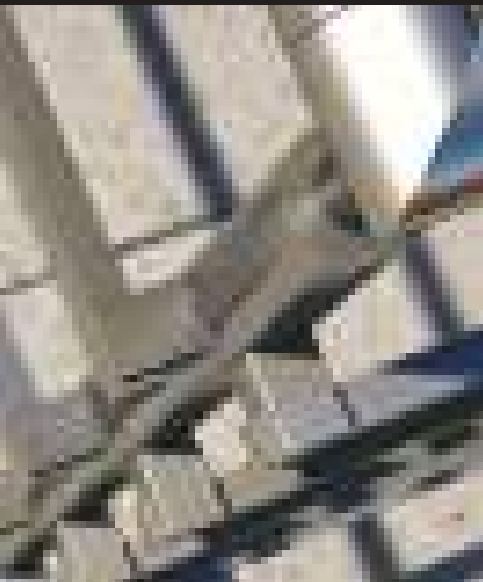
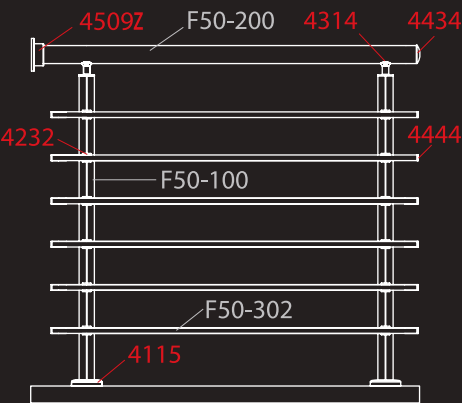
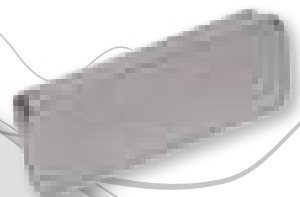



F50-102

COLUMNA DE SUJECIÓN 40 X 40

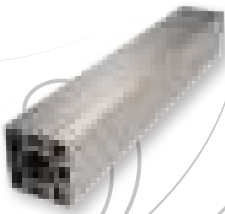

4122

PIE DE SUJECIÓN PARA COLUMNA F50-102, F50-106

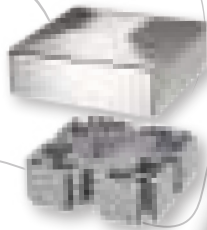

F50-201

PASAMANOS 30 X 80

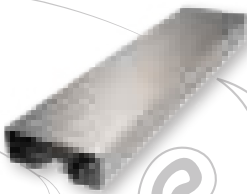

4328

UNIÓN COLUMNA PARA PASAMANOS



F50-302

RAIL CUADRADO 16 X 16 X 2 MM

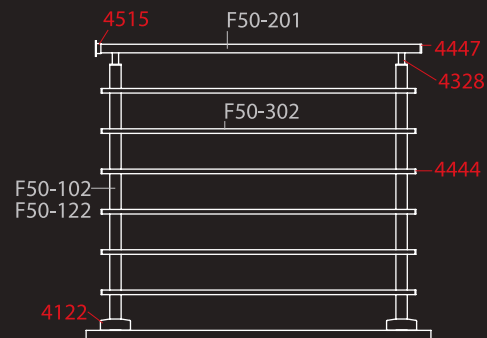

F-50 *Accord* Xsquare

Sistema de barandilla **Aluminio INOX**



F50-102
COLUMNA DE SUJECIÓN 40 X 40

4245
UNIÓN EXTERNA DEL PERFIL F50-102/106 PERFIL F50-302

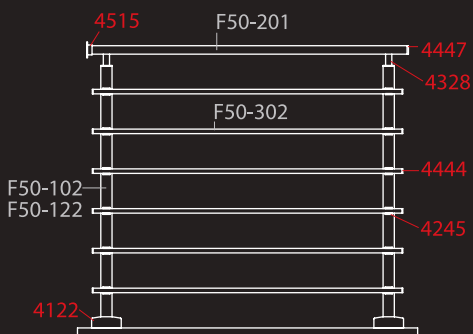
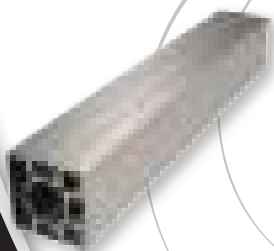

F50-302
RAIL CUADRADO 16 X 16 X 2 MM

4444
TAPA RAIL F50-302

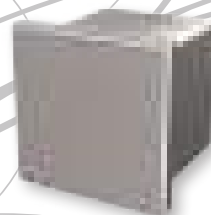
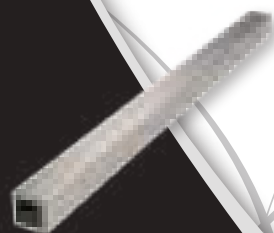

4515
EMBELLECEDOR PASAMANOS F50-201

4447
TAPA DE PASAMANOS F50-201

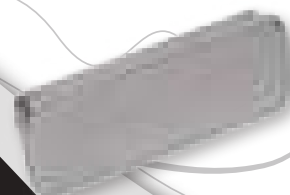
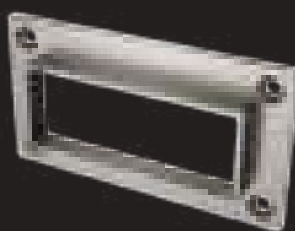

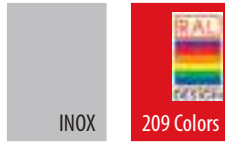

F50-102

COLUMNA DE SUJECIÓN 40 X 40

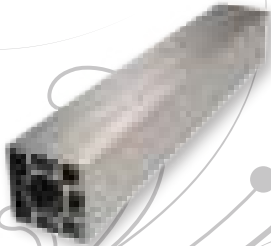

4244

UNIÓN EXTERNA DEL PERFIL F50-102/106 CON F26



F50-201

PASAMANOS 30 X 80

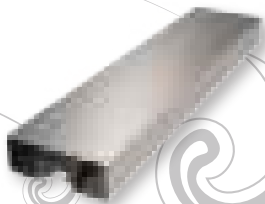

4328

UNIÓN COLUMNA PARA PASAMANOS



F50-304

RAIL CIRCULAR DE 26 X 2 MM



4515

EMBELLECEDOR PASAMANOS F50-201

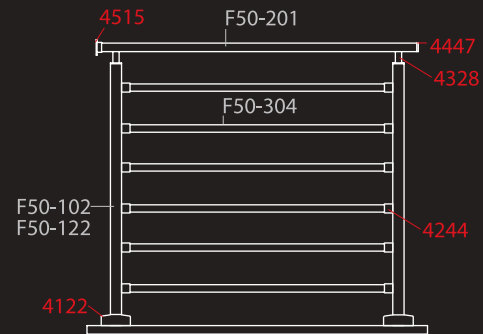

F-50 *Accord* Blade

Sistema de barandilla **Aluminio INOX**

INOX



4437

DECORACIÓN FINAL PARA ESCALERA F-16



F50-300

RAIL CIRCULAR DE 16 X 1,3 MM

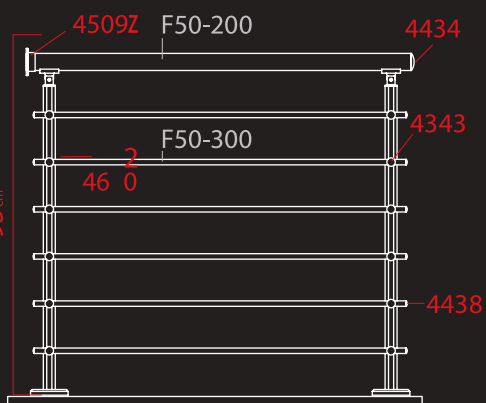
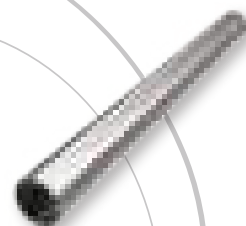

4343

UNIÓN COLUMNA 4620 CON F-16



4620

COLUMNA SUJECCIÓN PREPARADA A:
100 CM
95 CM
50 CM





INOX



209 Colors



F50-100

COLUMNA SUJECIÓN PERÍMETRO 42 MM



4112

PIE DE SEJUCCIÓN DE 12 REFORZADO PARA COLUMNA 9 F50-100



F50-200

PASAMANOS F-50 50 MM Ø



4168

SUJECIÓN CRISTAL HASTA 10 MM 8 - 10 MM

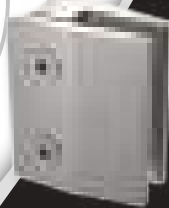

4509Z

EMBELLECEDOR PASAMANOS F-50



4314

SUJECIÓN PASAMANOS F-50 A COLUMNA

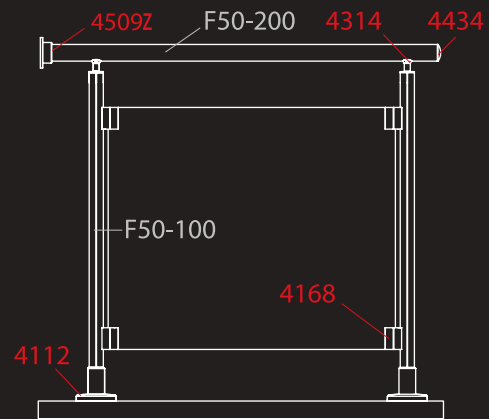
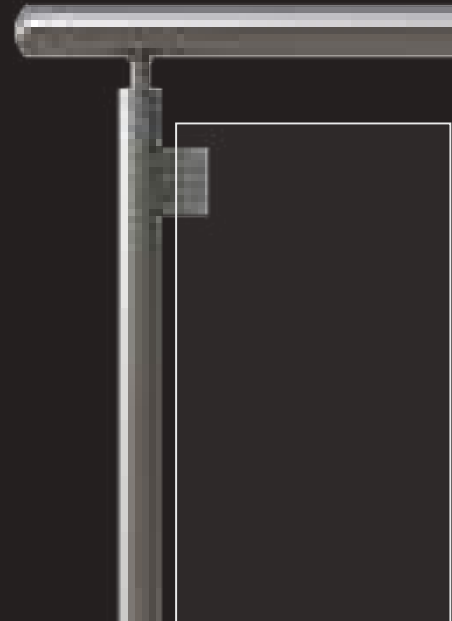

F-50 *Horizon* X-Rail

Sistema de barandilla **Aluminio INOX**

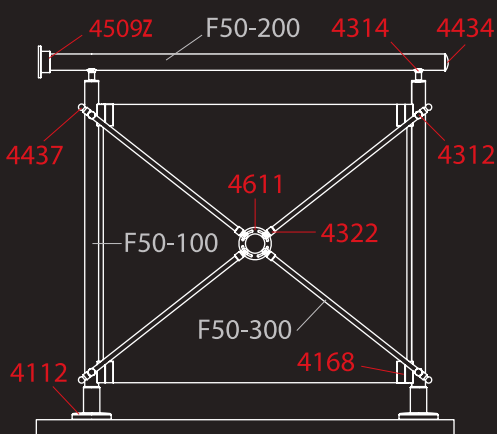

4168
SUJECIÓN CRISTAL DE 8 - 10 MM

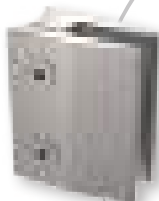

4323
ARTICULACIÓN ESQUINA F-16 UNIÓN CON COLUMNA

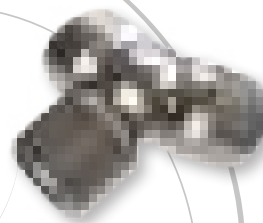

4314
SUJECIÓN PASAMANOS F-50



4611
ROSETA DECORATIVA CRISTAL

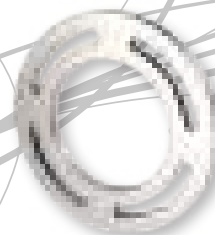

4322
UNIÓN ROSETA CRISTAL CON F-16



F50-100

COLUMNA SUJECIÓN PERÍMETRO 42 MM



4112

PIE DE SUJECIÓN DE 12 REFORZADO PARA COLUMNA F50-100



4167

SUJECIÓN COLUMNA F50-100/101 ASUELO



4173

PINZA DE CRISTAL REDONDA PARA 8-10 MM DE CRISTAL

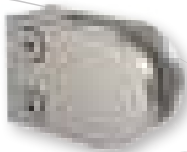

4312

UNIÓN COLUMNA HORIZONTAL PERFIL F-16 A 35 MM



F50-300

RAIL CIRCULAR DE 16 X 1,3 MM



4316

SUJECIÓN PASAMANOS F-50 A COLUMNA



4329

ARTICULACIÓN ESQUINA F-50 SIN AGUJERO



4611

ROSETA DECORATIVA CRISTAL



F-50 Horizon
X-Rail

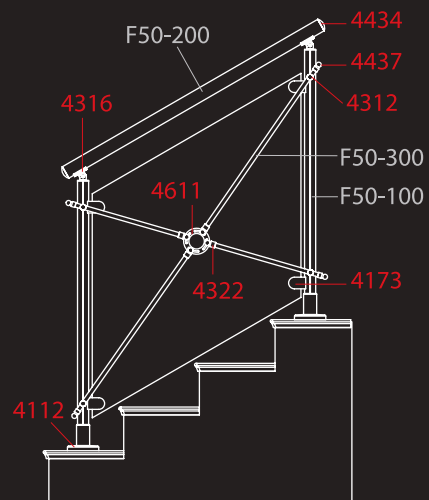
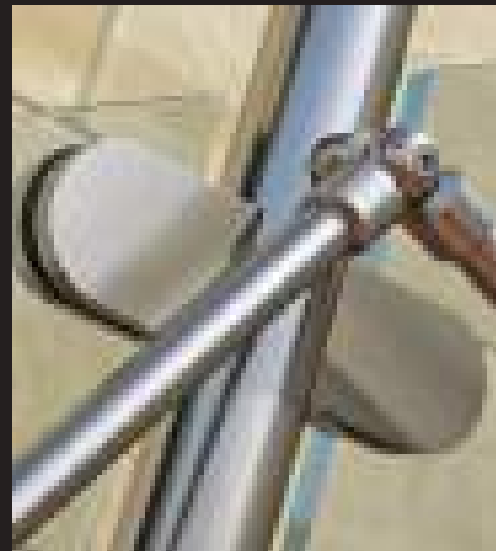

F-50 *Horizon* *Quattro*

Sistema de barandilla **Aluminio INOX**

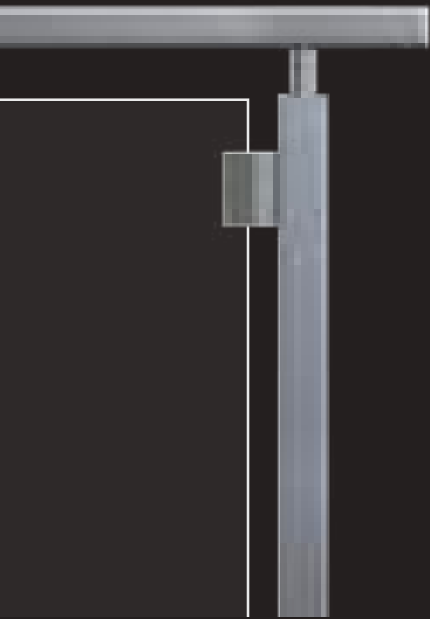

4122
PIÉ DE SUJECIÓN COLUMNA F50-102/106



4332
UNIÓN EN ESQUINA DE PASAMANOS F50-201

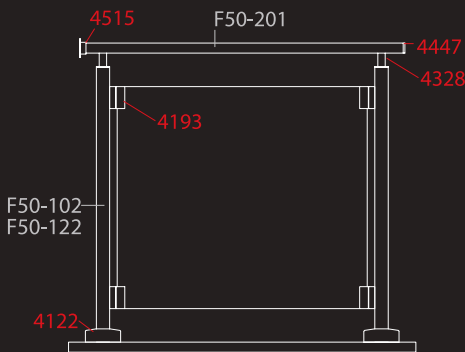
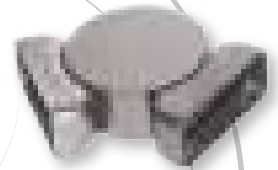

4193
SUJECIÓN PARA CRISTAL 8-10MM PARA COLUMNA F50-102



F50-102
COLUMNA DE SUJECIÓN 40 X 40

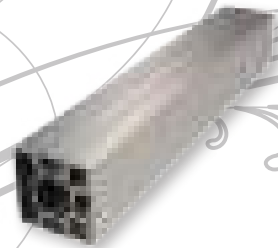

4328
UNIÓN COLUMNA PARA PASAMANOS



F50-201
PASAMANOS 30 X 80

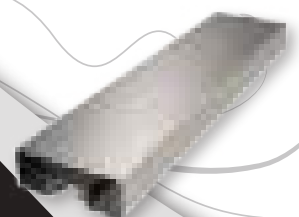

4121

PIÉ DE SUJECCIÓN COLUMNA F50-100



4335

ARTICULACIÓN PARA COLUMNA F50-100



4225

UNIÓN COLUMNA F50-100 A PERFIL F26



4434

TAPA PASAMANOS F50-200



4231

ARTICULACIÓN DE PASAMANOS EN 90º GRADOS



4509Z

EMBELLECEDOR PASAMANOS F-50



4314

SUJECCIÓN PASAMANOS F-50 A COLUMNA



4316

SUJECCIÓN PASAMANOS A F-50-100



F50-100

COLUMNA SUJECCIÓN PERÍMETRO Ø42 MM

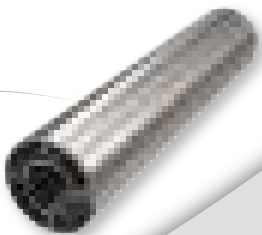

F50-200

PASAMANOS F-50



F50-305

RAIL PARA CRISTAL



F-50 *Horizon*

U-Rail

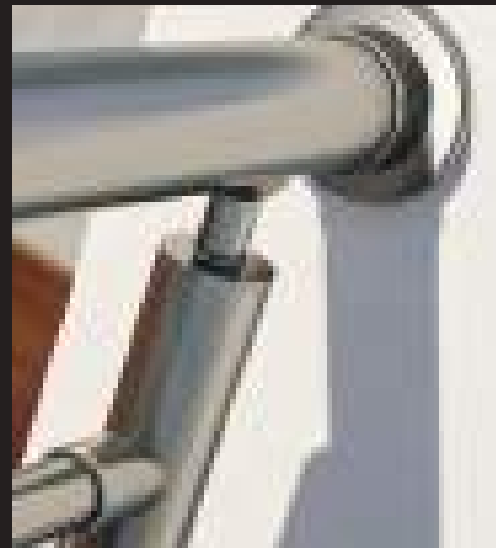
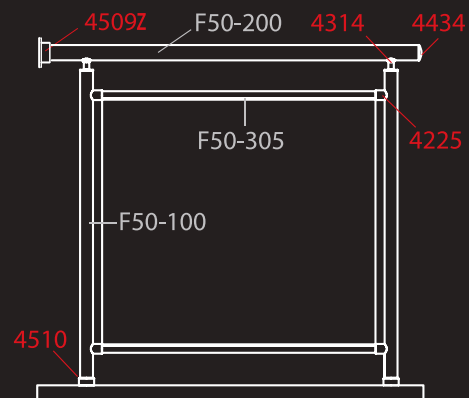
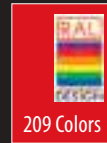

F-50 *Horizon* H-Rings

Sistema de barandilla **Aluminio INOX**

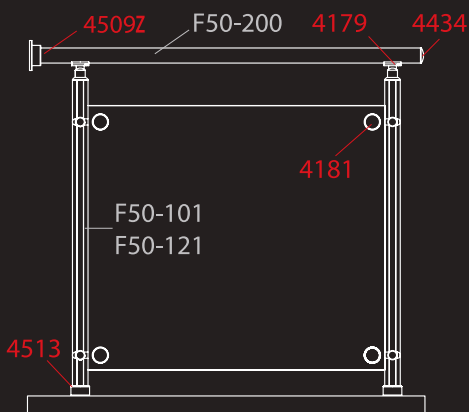

4179

SUJECIÓN PASAMANOS F50-200 A COLUMNA F50-101



4219

UNIÓN ESQUINA PASAMANOS

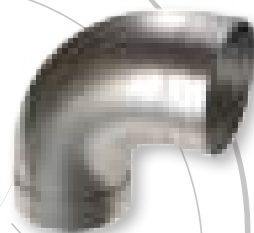

4181

SOPORTE BÁSICO DE CRISTAL EXTERNO A COLUMNA



4509Z

EMBELLECEDOR PASAMANOS F-50



4182

SOPORTE DOBLE DE CRISTAL EXTERNO A COLUMNA



F50-101

COLUMNA SUJECIÓN DE 50 MM





F50-106

COLUMNNA SUJECIÓN 40X40

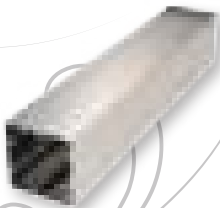

4122

PIÉ DE SUJECIÓN PARA COLUMNNA F50-102,106

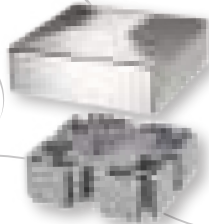

F50-203

PASAMANOS ENSAMBLADO 30X80 CPM F50-223



4332

UNIÓN EN EQUINA DE PASAMANOS F50-201/203



F50-310

RAIL DE CRISTAL 10-12MM Y PERFIL F50-302

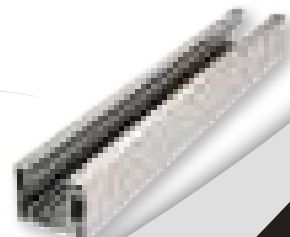

4452

TAPA RAIL F50-310

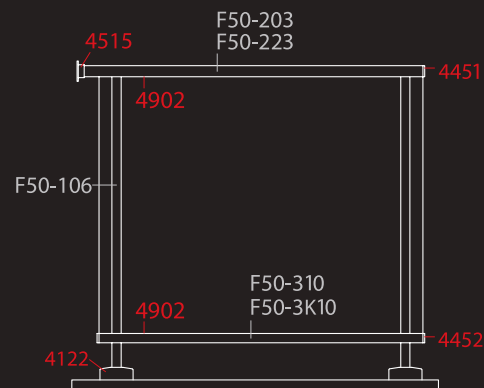

F-50 Vertical

Sistema de barandilla **Aluminio INOX**



INOX



209 Colors

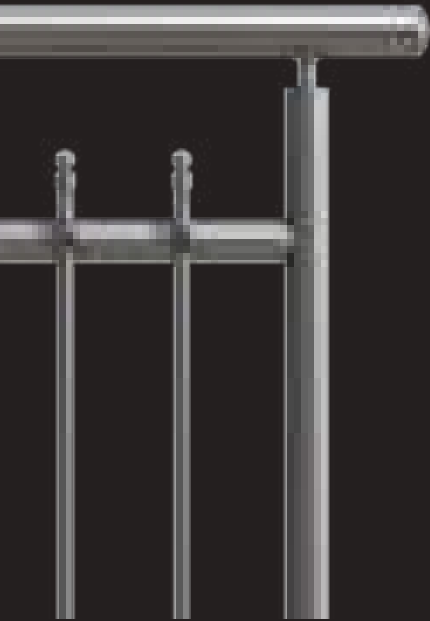

4224

UNIÓN DE COLUMNA A COLUMNA F50-100

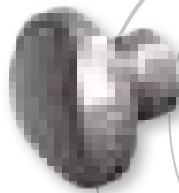

F50-100

COLUMNA SUJECCIÓN PERÍMETRO 42 MM



4312

UNIÓN COLUMNA HORIZONTAL PERFIL F-16 A 35 MM



F50-300

RAIL CIRCULAR DE 16 X 1,3 MM

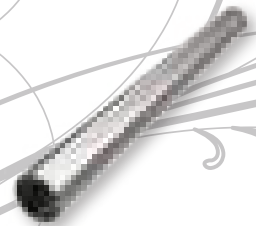

4437

DECORACIÓN FINAL PARA ESCALERA F-16

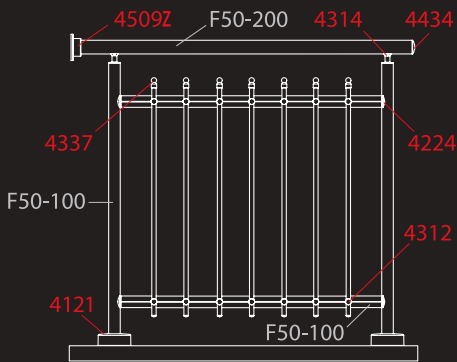



4231

ARTICULACIÓN DE PASAMANOS EN 90º GRADOS



4314

SUJECIÓN PASAMANOS F-50 A COLUMNA



4225

UNIÓN ENTRE COLUMNA F50-100 CON F26

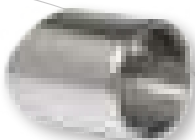

4618

DECORACIÓN BARROTE



F50-303

PERFIL ESPECIAL 16 MM

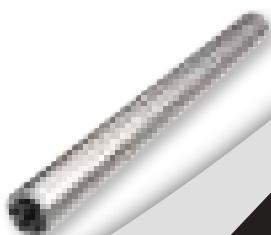

F50-306

RAIL ESPECIAL DE 26 MM PARA PERFIL F50-303

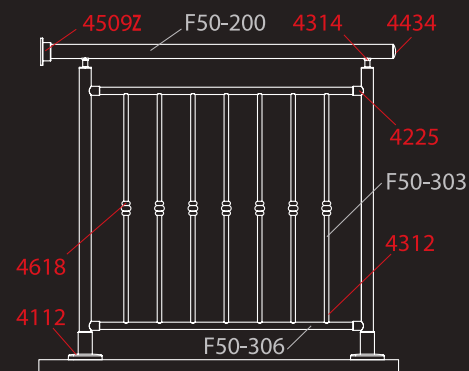

F-50 Vertical

D

Sistema de barandilla **Aluminio INOX**



INOX



209 Colors

4332

UNIÓN EN ESQUINA DE PASAMANOS F50-201/203



4240

UNIÓN DE COLUMNA CON RAIL



4447

TAPA DE PASAMANOS F50-201

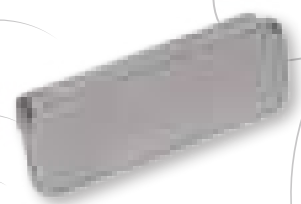

4328

UNIÓN COLUMNA PARA PASAMANOS



4514

EMBELLECEDOR DE COLUMNA F50-201

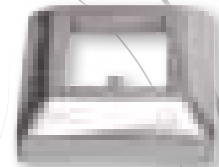

4670

BARROTE SAZA F50 VERTICAL-D

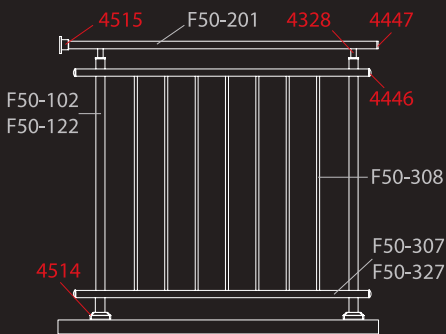

4515

EMBELLECEDOR PASAMANOS F50-201/203



INOX



209 Colors

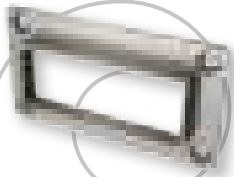

F50-311

PERFIL PARA RAIL F50-310 Y PASAMANOS F50-203

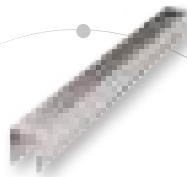

F50-106

COLUMNA SUJECIÓN 40X40

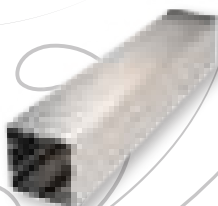

4122

PIE DE SUJECIÓN PARA COLUMNA F50-102/106

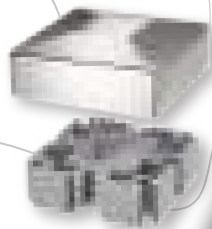

F50-203

PASAMANOS 30X80

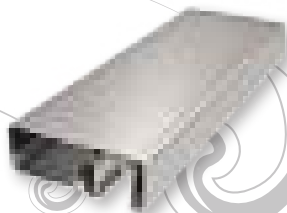

4332

UNIÓN EN EQUINA DE PASAMANOS F50-201/203



F50-310

PERFIL U PARA CRISTAL 10-12MM CON TAPA

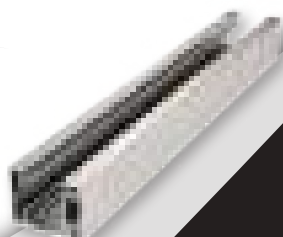

4451

TAPA PASAMANOS F50-203



F-50 Vertical

Q

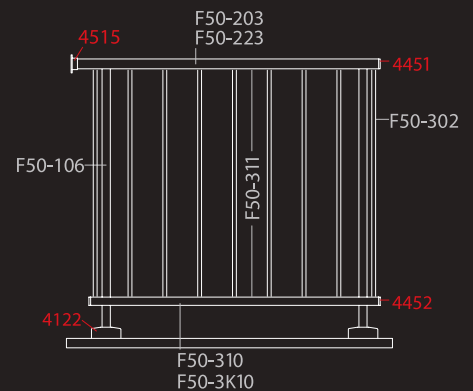
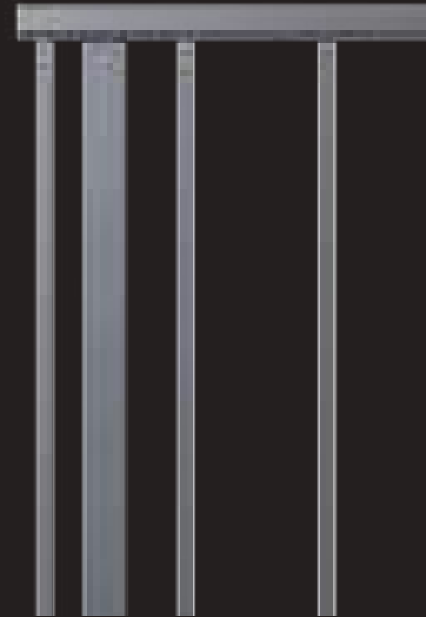

F-50 Perfiles Aluminio Inox

F50-100
COLUMNA SUJECION PERIMETRO 42 MM

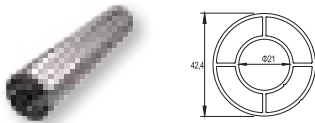

F50-200
PASAMANOS F-50 (50 MM)

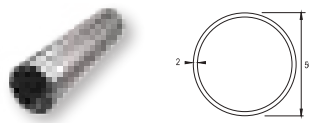

F50-101
COLUMNA SUJECIÓN DE 50MM



F50-121
TAPA EMBELLECEDORA DE COLUMNA

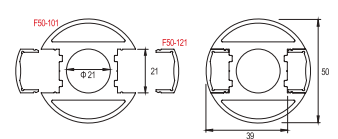

F50-102
COLUMNA SUJECIÓN 40 X 40



F50-122
TAPA EMBELLECEDORA COLUMNA F50-102

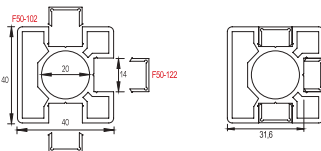

F50-103
COLUMNA SUJECIÓN PERIMETRO 42 MM



F50-123
TAPA EMBELLECEDORA DE COLUMNA F50-103

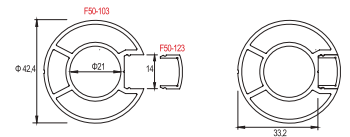

F50-106
COLUMNA SUJECIÓN 40X40 MM

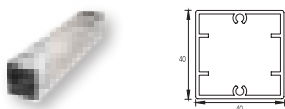

F50-201
PASAMANOS 30 X 80

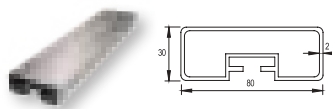

F50-203
PASAMANOS 30X80



F50-223
TAPA EMBELLECEDORA DE COLUMNA F50-203

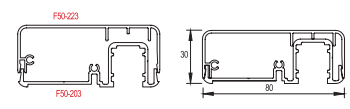

F50-300
PERFIL F-16 X 1.3 MM DE GROSOR

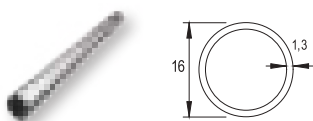

F50-301
PERFIL F-16 X 3.5 MM DE GROSOR

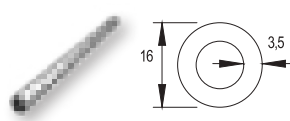

F50-302
RAIL CUADRADO 16 X 16 X 2 MM

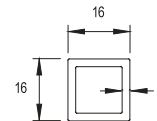

F50-303
RAIL ESPECIAL 16MM

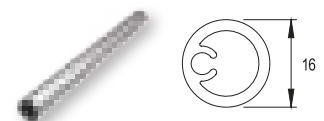

F50-304
PERFIL DE 26 MM

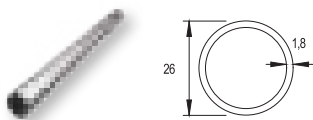

F50-305
RAIL F-26 PARA CRISTAL DE 10 MM.

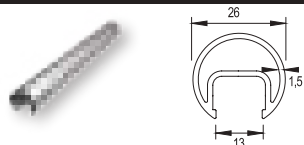

F50-306
RAIL ESPECIAL DE 26 MM PARA F50-303

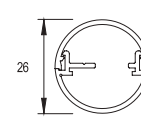

F50-307
PERFIL DIAMETRO 30MM



F50-327
TAPA EMBELLECEDORA DE F50-307

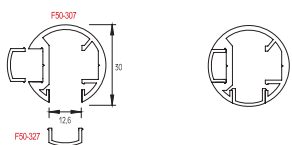

F50-308
COLUMNA CUADRADA DE 12 X 12 X 2MM

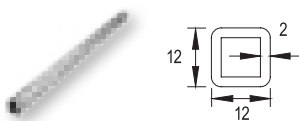

F50-311
PERFIL-TAPA RAIL F50-310 Y PASAMANOS F50-203



F50-310
PERFIL -U- PARA CRISTAL 10-12 mm



F50-3K10
TAPA EMBELLECEDORA

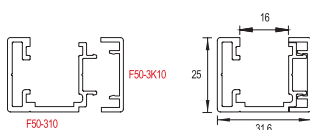

F-50 Accesorios Aluminio Inox

4112
PIE DE SUJECIÓN DE 12 CM. REFORZADO PARA COLUMNA F50-100

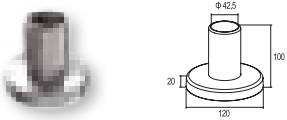

4115
PIE DE SUJECION PARA COLUMNA F50-100



4116
SOPORTE DE 8.5 CM PASAMANOS A MURO



4117
PIE DE SUJECIÓN DE 12CM PARA COLUMNA F50-100

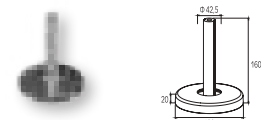

4119
PIE DE SUJECIÓN DE 12 CM. PARA COLUMNA F50-101

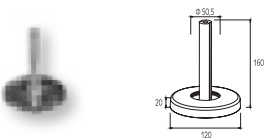

4121
PIE DE SUJECIÓN. PARA COLUMNA F50-100

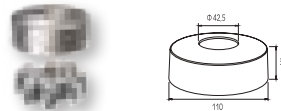

4122
PIE DE SUJECION PARA COLUMNA F50-102, F50-106

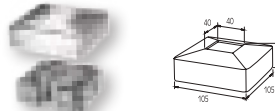

4165
UNIÓN PARED PASAMANOS F50-200

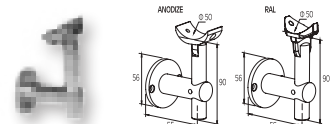

4166
SUJECIÓN COLUMNA A PARED F50-100

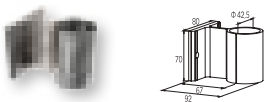

4167
SUJECIÓN COLUMNA F50-100 & F50-101 AL SUELO



4168
PINZA DE SUJECIÓN CRISTAL DE 8 A 10MM



4169
SUJECIÓN PASAMANOS F-50 COLUMNA

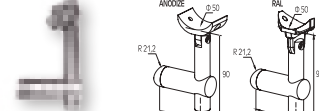

4172
PINZA DE SUJECION 6-8 MM

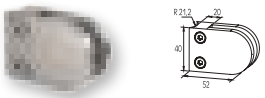

4173
PINZA DE SUJECION CRISTAL 8-10 MM (45 X 65)

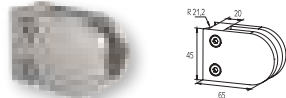

4177
VISAGRA PARA COLUMNA F50-100



4179
SUJECIÓN PASAMANOS F50-200 COLUMNA F50-101



4180
SUJECIÓN EXTERNA A PASAMANOS

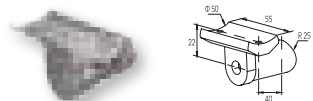

4181
SOPORTE BÁSICO DE CRISTAL EXTERNO A COLUMNA

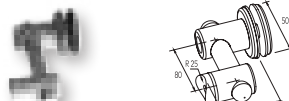

4182
SOPORTE EXTERNO CRISTAL DOBLE DE 8-10MM



4184
SOPORTE EXTERIOR COLUMNA F 50-101

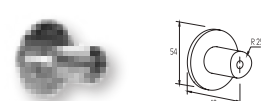

4186
CERROJO PARA LA COLUMNA F50-100

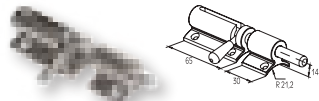

4188
SUJECION PARA COLUMNA F50-102 AL SUELO



4189
PINZA PARA CRISTAL 8-10MM COLUMNA F50-102

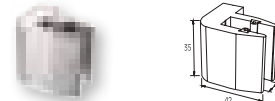

4190
PINZA DOBLE PARA CRISTAL 8-10MM COLUMNA F50-102

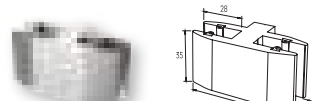

4191
PINZA PARA CRISTAL DE 8-10mm PARA COLUMNA F50-103



4192
PINZA DOBLE PARA CRISTAL DE 8-10mm COLUMNA F50-103

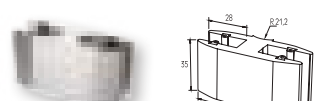

4193
PINZA PLANA PARA CRISTAL 8-10MM COLUMNA F50-102, F50-106



4194
PIE DE SOPORTE EXTERIOR 15 CM. PARA COLUMNA F50-100

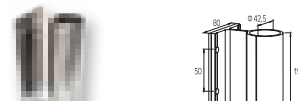

4218
UNIÓN PASAMANOS



4219
UNIÓN ESQUINA PASAMANOS 90°

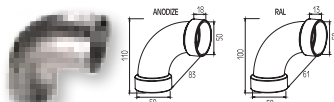

4224
UNIÓN COLUMNA-COLUMNA F 50-100

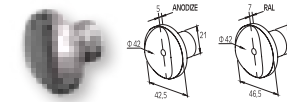

4225
UNIÓN ENTRE COLUMNA F50-100 PARA PERFIL F26

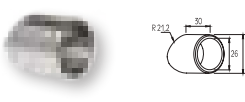

F-50 Accesorios Aluminio Inox

4228
VARILLA CONECTARÁ F16 EN 90°

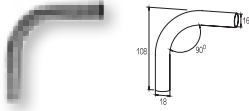

4229
VARILLA CONECTARÁ F16 EN 135°

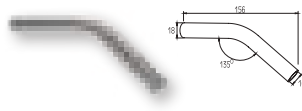

4230
UNION VARILLA CON VARILLA DE F16



4231
UNIÓN PASAMANOS EN 90°

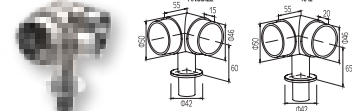

4232
UNIÓN COLUMNA F50-100 CON PERFIL F50-302 (SUJECION EXTERIOR) COLUMNA COD. 934

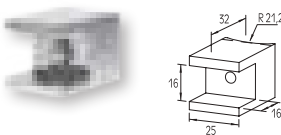

4235
ARTICULACIÓN DE PASAMANOS EN 90° PARA F50-101



4240
UNIÓN DE COLUMNA CON RAIL F50-307 CON F50-102

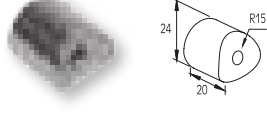

4241
UNIÓN DE PASAMANOS CON PASAMANOS (INTERIOR)

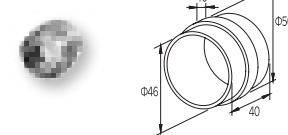

4242
UNIÓN DE RAIL A RAIL

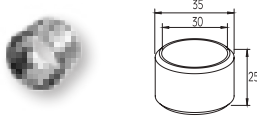

4243
UNIÓN ENTRE RAILES EN 90°

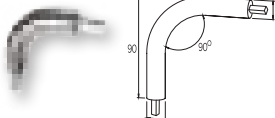

4244
UNIÓN EXTERNA DEL PERFIL F50-102/106 CON F26



4245
UNIÓN EXTERNA DEL PERFIL F50-102/106 Y PERFIL F50-302

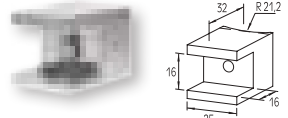

4249
UNION DE PASAMANOS 80X30mm

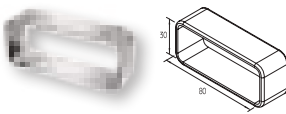

4250
UNION DE PASAMANOS EN 90° PARA F50-201

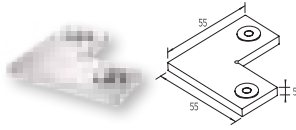

4302
ARTICULACIÓN REGULABLE PARA PERIL F-16

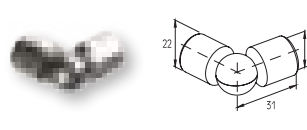

4312
UNIÓN COLUMNA F50-100 PARA PERIL F-16

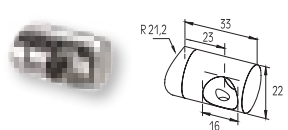

4314
SUJECIÓN PASAMANOS A COLUMNA

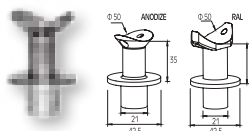

4316
SUJECIÓN PASAMANOS F-50 A COLUMNA F50-100 (ESCALERA)

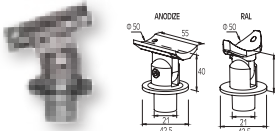

4319
ARTICULACION ESQUINA F-50

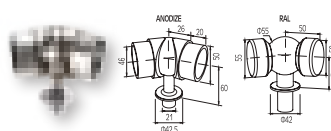

4322
UNIÓN ROSETA CRISTAL CON F-16

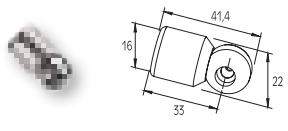

4323
ARTICULACIÓN ESQUINA F-16 CON COLUMNA F50-100

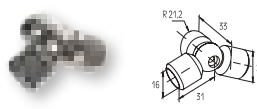

4324
UNION EN HORIZONTAL DE PERIL F-16 COLUMNA F50-100

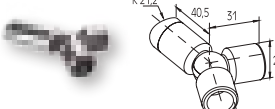

4328
UNIÓN COLUMNA CON PASAMANOS F50-102 CON F50-201

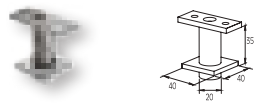

4329
ARTICULACION ESQUINA F-50 PASAMANOS

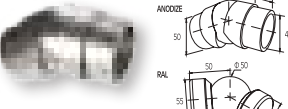

4332
UNIÓN EN ESQUINA DE PASAMANOS F50-201, F50-203

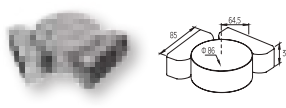

4333
ARTICULACION PARA PASAMANOS EN ESQUINA AF50-307

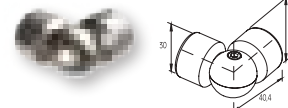

4335
ARTICULACIÓN COLUMNA F50-100 CON PERIL F26

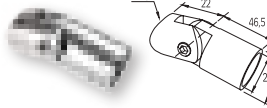

4337
UNIÓN COLUMNA CON PASAMANOS F50 100 CON F50-201

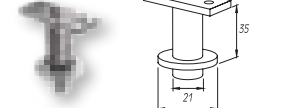

4341
UNION COLUMNA F50-100 CON PERIL F50-302 (16X16)

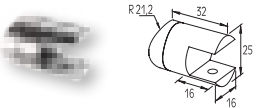

4342
UNIÓN EN ESQUINA DE RAIL F50-302 (16X16)

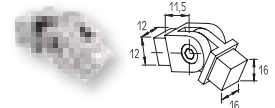

4343
UNION DE COLUMNA 4620 PARA F-16

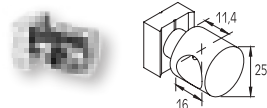

4434
TAPA PASAMANOS F50-200

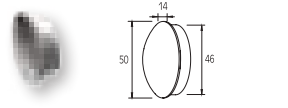

F-50 Accesorios Aluminio Inox

4435
TAPA PERFIL F50-301 (F-16 X 35 MM)

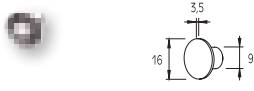

4436
TAPA COLUMNA F50-100

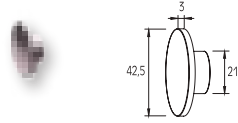

4437
DECORACIÓN FINAL PARA ESCALERA F-16

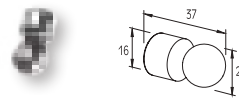

4438
TAPA PERFIL F50-300(F-16 X 13 MM)

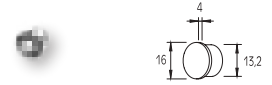

4443
TAPA COLUMNA F50-101

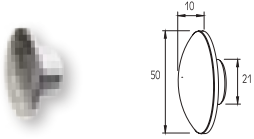

4444
TAPA PARA RAIL F-50-302(16X16)

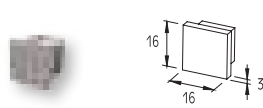

4446
TAPA RAIL F50-307

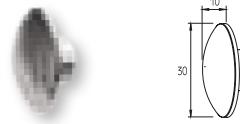

4447
TAPA DE PASAMANOS F50-201

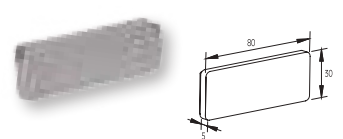

4448
TAPA COLUMNA F50-102

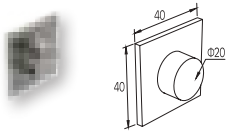

4451
TAPA PASAMANOS F50-203

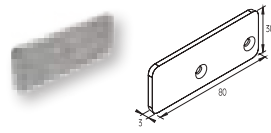

4452
TAPA RAIL F50-310

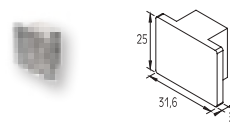

4509
EMBELLECEDOR PASAMANOS

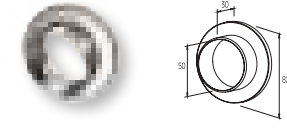

4509A
SUJECION PARED A COLUMNA F-200

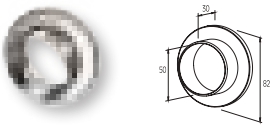

4509Z
EMBELLECEDOR CON TAPA

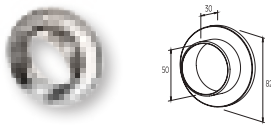

4510
EMBELLECEDOR COLUMNA F50-100

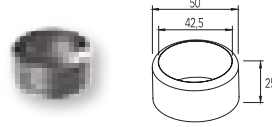

4513
UNIÓN COLUMNA -COLUMNA F50-101

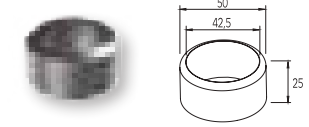

4514
EMBELLECEDOR DE COLUMNA F50-102

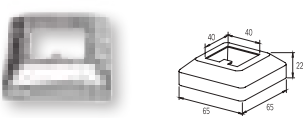

4515
UNION PASAMANOS A PARED F50-201.F-50-203

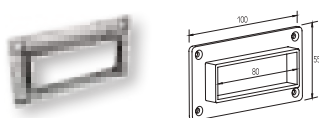

4611
ROSETA DECORATIVA CRISTAL



4618
DECORACIÓN PERFIL PARA ESCALERA F-16

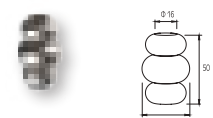

4620
COLUMNA DE SUJECION PREPARADA

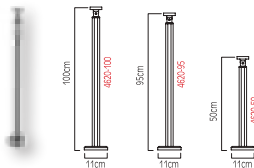

4670
PERFIL CURVADO PARA VERTICAL-D

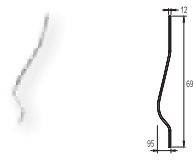

4680
PERFIL CURVADO PARA VERTICAL-D

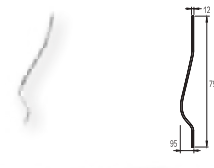

Glass Supporting System

Crystalline[®] railing system





SISTEMA INTEGRADO DE BARANDILLA PANORAMICA

Este sistema se compone de cuatro elementos diferenciados:

El sistema de fijación al suelo. Se trata de un perfil de aluminio de acabado y características especiales que nos sirven de BASE o GUÍA para incorporar el cristal.

El segundo, el cristal. Aconsejamos cristal de seguridad triple. El sistema admite un grosor de 16mm y una altura de 1000mm.

Tercero, el embellecedor, que nos da un acabado ovalado. Es la clave de la fácil y rápida colocación de esta barandilla. Este embellecedor se ofrece en una amplia gama de colores y acabados, incluidos anodizados inox y colores imitación madera y por último, el pasamanos que nos proporciona robustez y estabilidad al conjunto.



CUALIDADES

- Estética inigualable.
- Visión panorámica
- Fácil limpieza y mantenimiento
- Soluciones de montaje económico
- Fabricado según prototipo
- Sistema registrado bajo patente

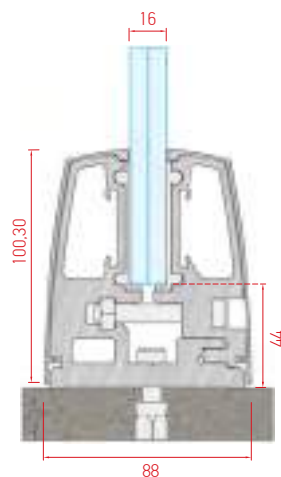

F85-1K1

F85-150A



Tipo B



SISTEMA REGULABLE DE BARANDILLA PANORÁMICA

Este sistema regulable se compone de un perfil de aluminio especialmente diseñado para la fabricación de una barandilla con cristal panorámico en una superficie ya acabada o rematada.

Las bases se insertan en un segundo rail guía para una mejor sujeción y alineación de las mismas. A continuación se colocan los embellecedores o tapas de aluminio. El sistema acepta cristales de seguridad triple de grosor 16/20mm y una altura máxima de 1000mm.

CUALIDADES

- Sistema regulable en los dos sentidos (vertical A y horizontal B).
- Con rail-guía de fácil instalación. Este rail nos sirve para insertar las bases de aluminio.
- Puntos de presión preparados para la sujeción de los cristales a las bases.
- Perfil adaptable a cristal triple de seguridad 16/20mm.
- Según prototipo UNI EN 10807 & VF P01 - 013.
- Sistema consolidado bajo patente

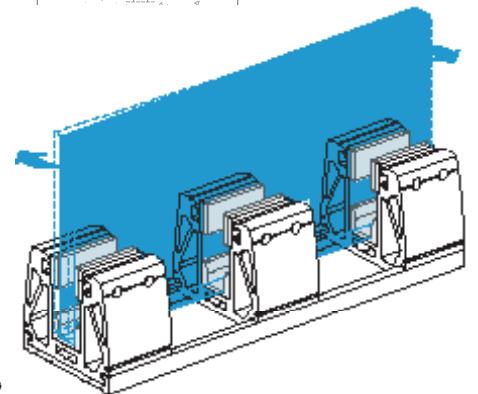
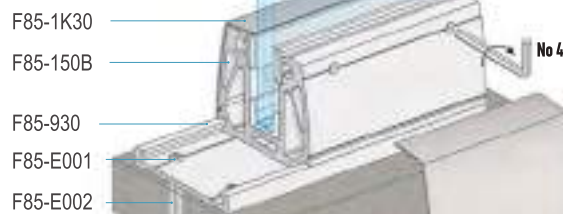
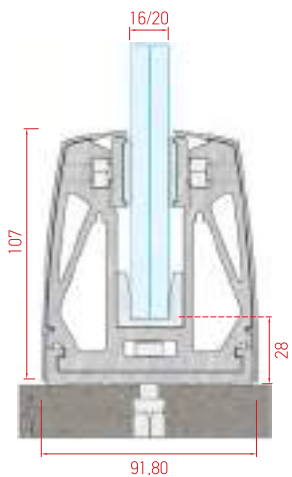
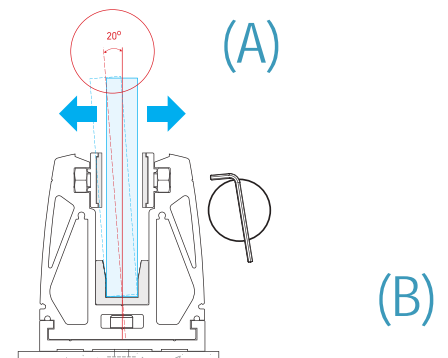



SISTEMA INTEGRADO DE BARANDILLA DE CRISTAL.

Sistema de barandilla de cristal y perfil de aluminio. Las bases de fijación se adaptan a cristales de seguridad triples 16/20mm y altura hasta 1000mm. Cubrimos con un perfil embellecedor las bases de aluminio.

Este perfil está especialmente diseñado con una línea más rectangular y que se insertan de tal modo que en el caso de sustitución de los cristales por rotura o deterioro, estaría preparado para no provocar desperfectos

CUALIDADES

- Sistema muy versátil que sirve para cualquier tipo de construcción (interior, exterior)
- Fijación especial del cristal al perfil por puntos de presión, que le aprisionan en el mismo.
- Adaptable a cristal de seguridad triple 16/20mm.

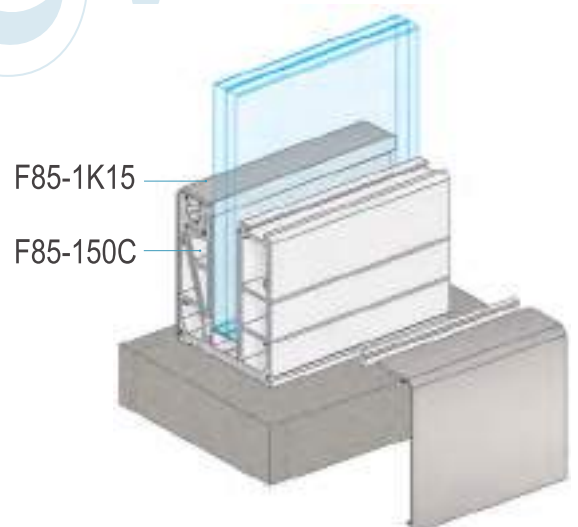
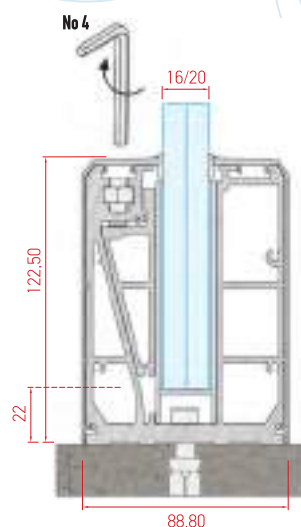



SISTEMA DE BARANDILLA DE CRISTAL FIJADA BAJO SUPERFICIE

Este sistema permite aún más la visión panorámica de paisaje. Nivelado a la misma altura de la superficie final. Las bases incorporan unas gomas y tapas que permiten que el sistema quede hermético. El sistema admite cristal de seguridad triple de 16/20mm y altura de 1000mm.

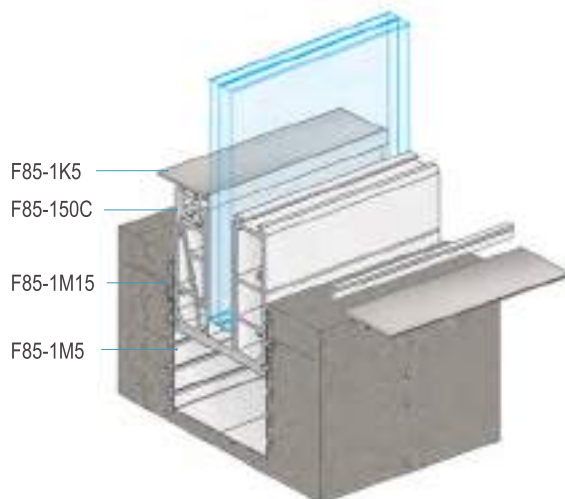
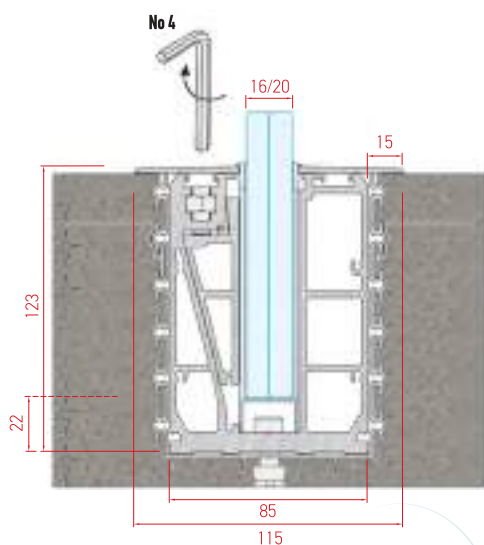



SISTEMA DE SUJECIÓN EXTERIOR PARA BARANDILLAS DE CRISTAL

Las bases de sujeción van fijadas en un perfil especial de aluminio que se atornilla al forjado. Este está preparado para recibir un cristal de seguridad de 16/20mm de grosor y una altura máxima de 1000mm. El cristal finalmente queda atornillado de una manera sencilla y segura al exterior.

CUALIDADES

- Estéticamente moderno
- Vistas sin obstáculos
- Cristales de seguridad de 16/20mm

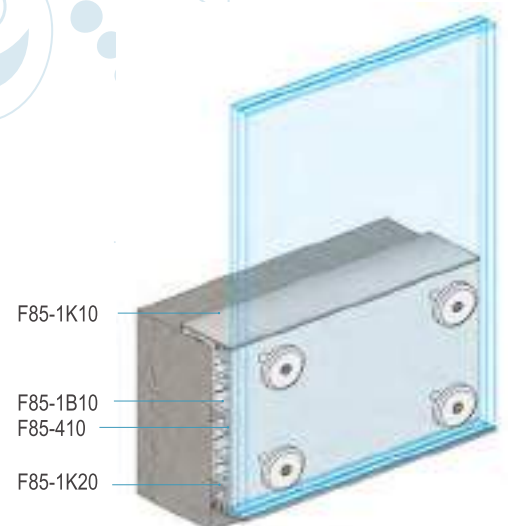
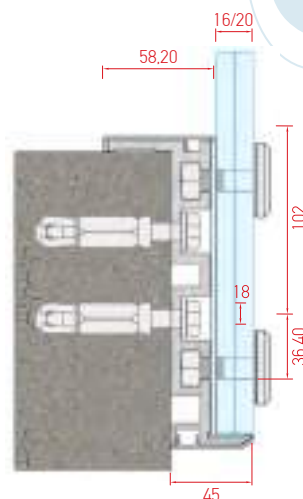

Tipo Ds



INOX SISTEMA EXTERIOR DE BARANDILLA Y ESCALERAS

Para la sujeción exterior de barandilla y escalera con cristal proponemos el sistema MINI de acero inoxidable satinado.

El sistema se compone de unas bases de sujeción de diámetro \varnothing 40mm a su vez nos da la posibilidad de incorporarlo bien en escaleras o balcones de cristal.

CUALIDADES

- De fácil instalación.
- Especialmente diseñado para balcones.
- Preparado para cristal de seguridad de 10/20mm (triple seguridad)

F85 - E001
F85 - E002

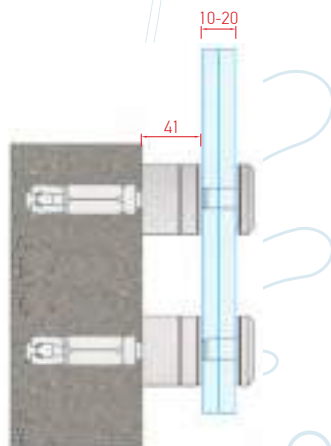

4149

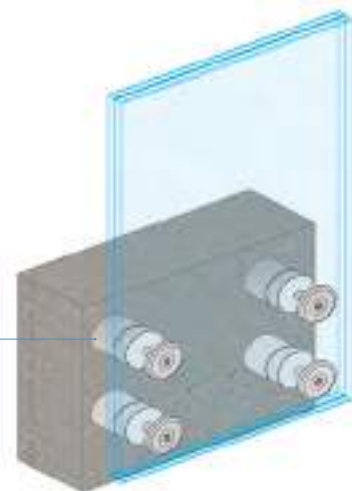

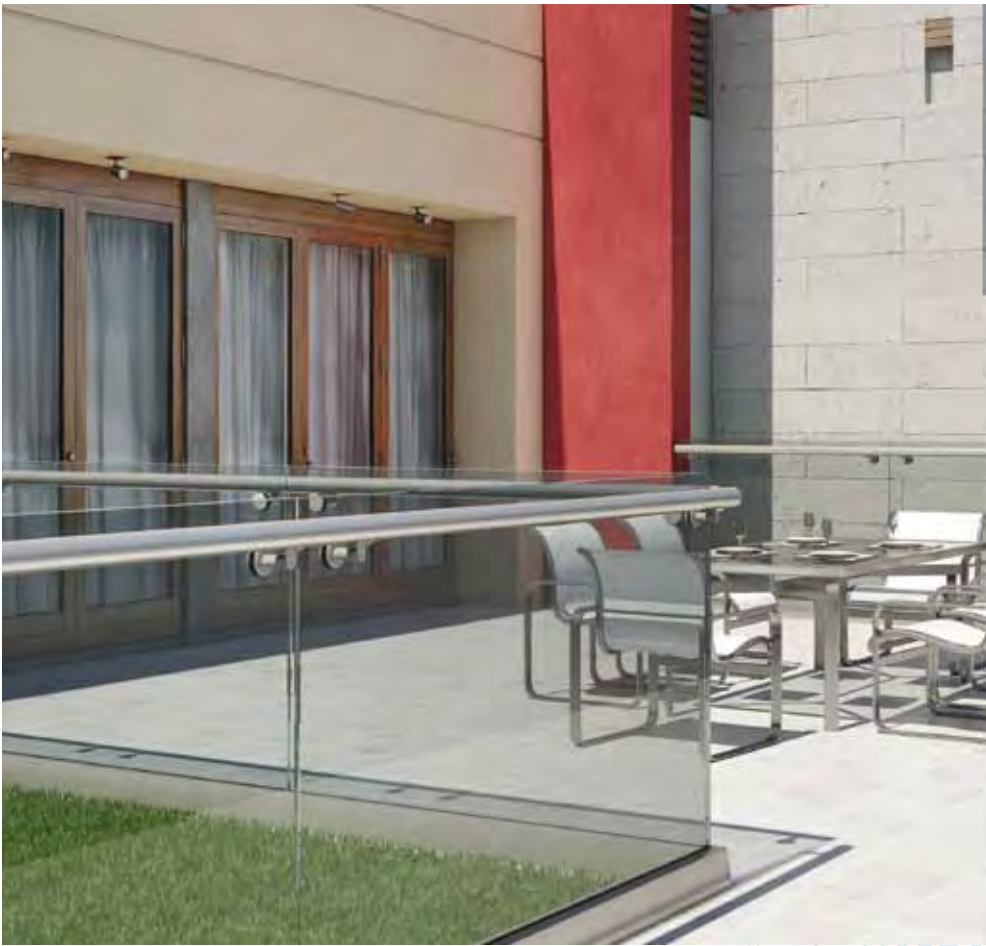

El sistema CRYSTAL LINE se presenta solo con cristal de 16/20mm (triple de seguridad) con acabado pulido.

Aluminco intentando proponer diferentes acabados, presenta 3 pasamanos, todos ellos diferentes en diseño y medida. El redondo de Ø 50 (imagen 1), ovalado 76mm (imagen 2) y redonda con soporte exterior que sujeta pasamanos completamente redondo Ø50 (imagen 3 y 4) variando el soporte que le sujeta al cristal. Sus acabados y colores pueden ir en armonía con el resto del conjunto.

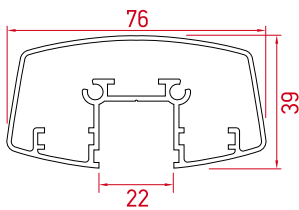

Cod. F85-200

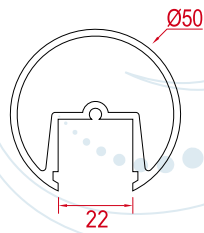

Cod. 85-201

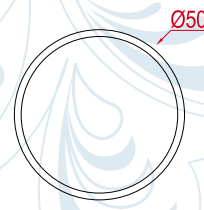

Cod. F50-200

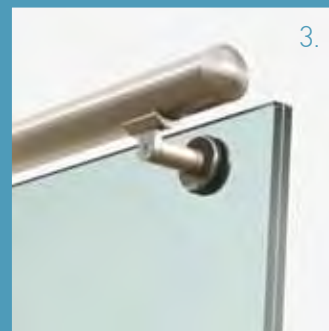
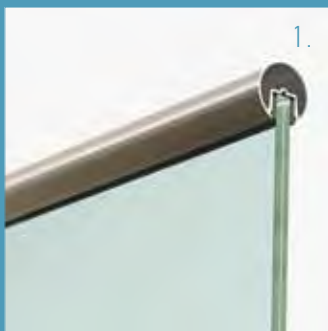

MÓDULOS SAZA



ALTURA **35 cm**

Altura para barandilla entre 45-62 cm

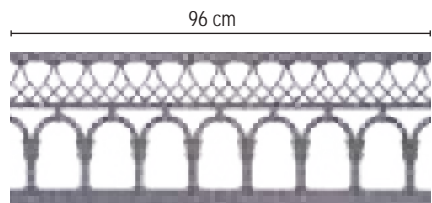

Código

Modelo

35 - 01

KAMARA

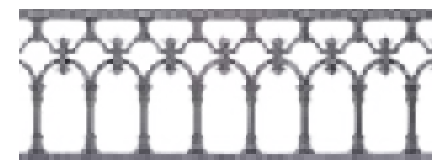

35 - 02

VIENES



35 - 03

MACRIGIANNI

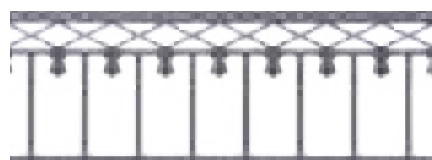

35 - 04

KOLONATO

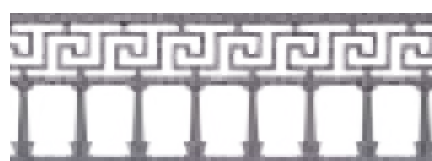

35 - 05

ATENIENSE

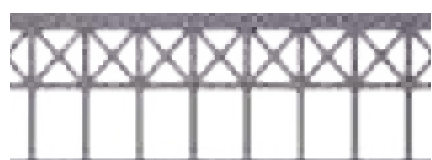

35 - 06

INTERNACIONAL



35 - 07

GIRNALDA



35 - 08

LINEAL

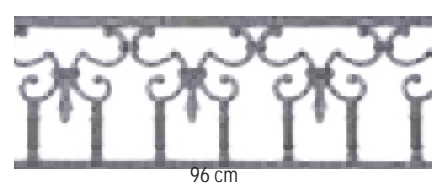

35 - 09

KNOSOS



ALTURA 35 cm

Altura para barandilla entre 45-62 cm

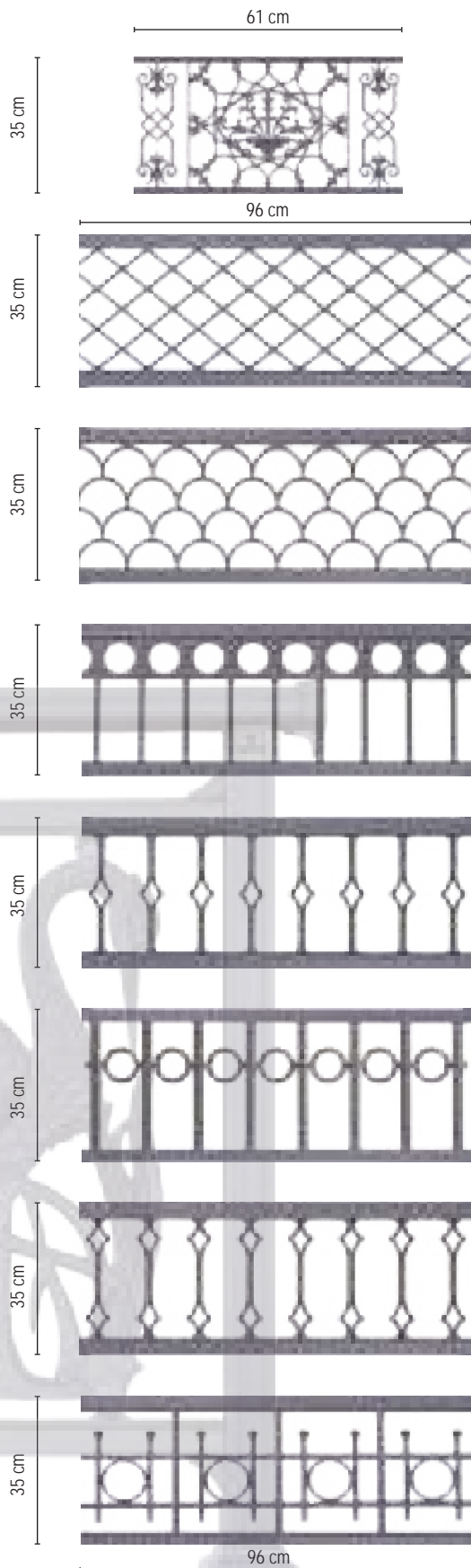

Código

Modelo

35 - 10

RAMO

35 - 11

CELOSIA

35 - 12

COLMENA

35 - 13

SERIFO

35 - 14

ESTRELLA A

35 - 15

OLYMPIC.

35 - 16

ESTRELLA B

35 - 17

KIKLADES

ALTURA 42 cm

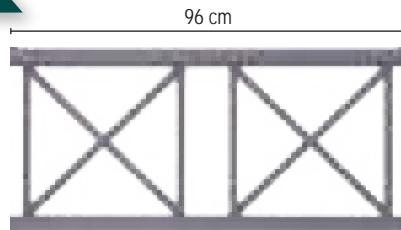

COD. 42-01 MOD. CLÁSICO A

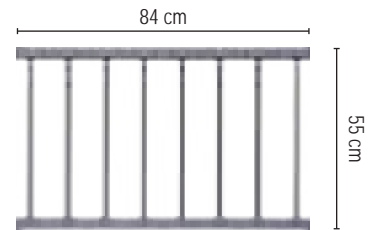

COD. 42-02 MOD. LINEAL

ALTURA 50 cm

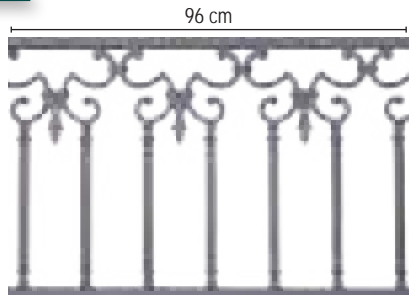

COD. 50-01 MOD. KNOSOS

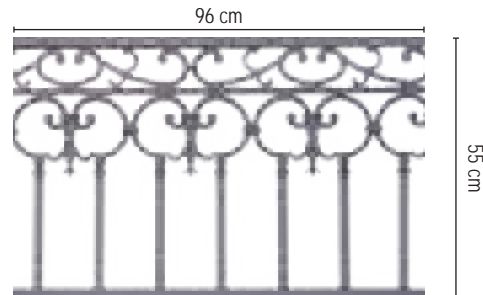

COD. 50-02 MOD. FESTOS

ALTURA 55 cm

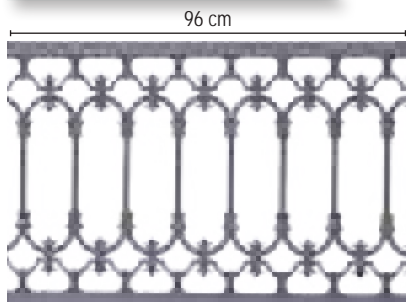

COD. 55-01 MOD. VIENES

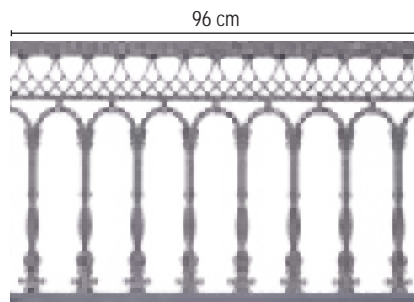

COD. 55-02 MOD. KAMARA

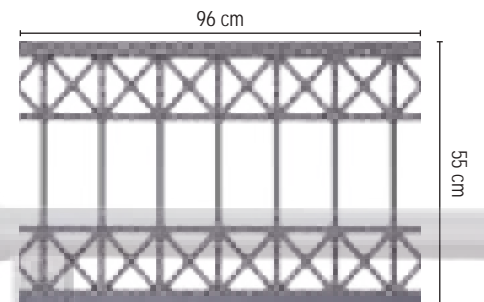

COD. 55-03 MOD. INTERNACIONAL

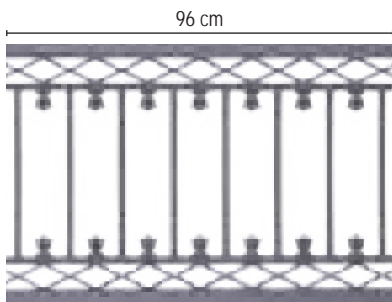

COD. 55-04 MOD. KOLONATO

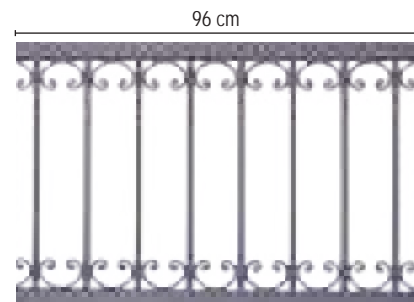

COD. 55-05 MOD. MACRIGIANNI

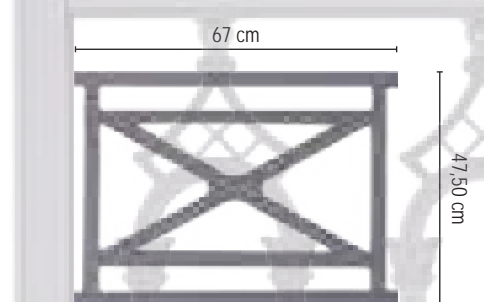

COD. 55-06 MOD. CRISMAS

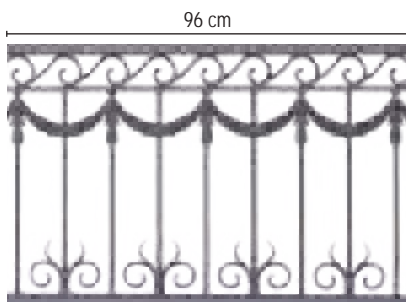

COD. 55-07 MOD. GIRNALDA

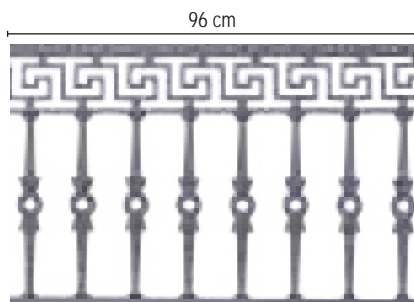

COD. 55-08 MOD. ATENIENSE

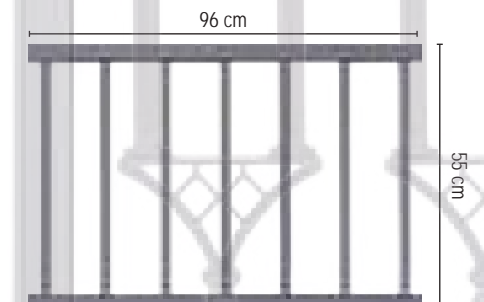

COD. 55-09 MOD. LINEAL

SISTEMA LINEAL ABROCHADO
 El sistema está patentado
 N° Patente: 20000200038

ALTURA 55 cm

Altura para barandilla entre 65-82 cm

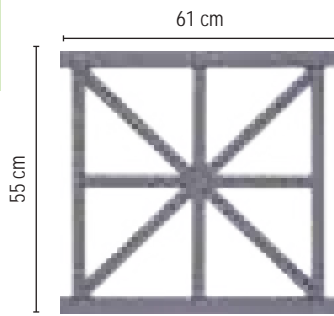

COD. 55 - 10 MOD. LINEAL

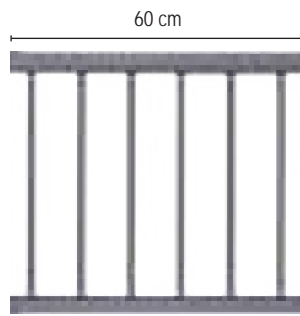

COD. 55 - 11 MOD. LINEAL

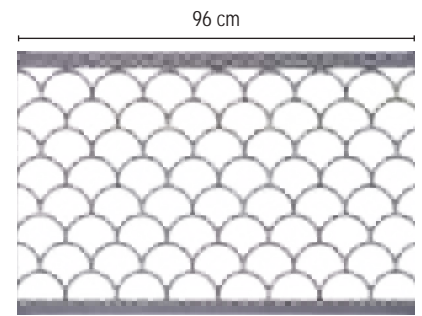

COD. 55 - 12 MOD. COLMENA

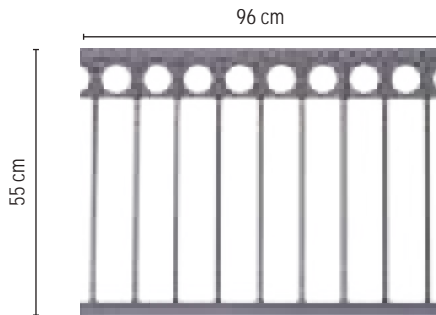

COD. 55 - 13 MOD. SERIFO

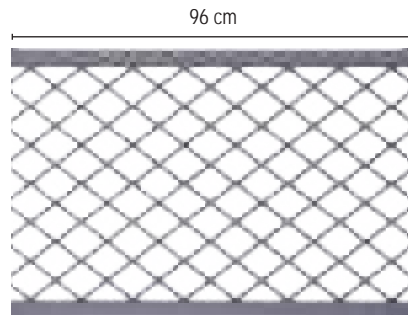

COD. 55 - 14 MOD. CELOSIA

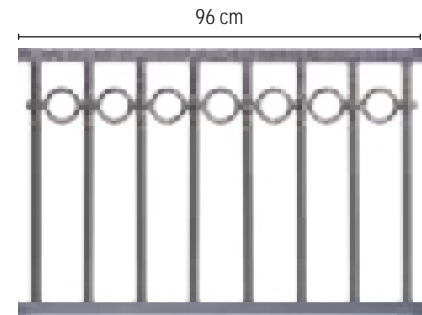

COD. 55 - 15 MOD. OLYMPIC

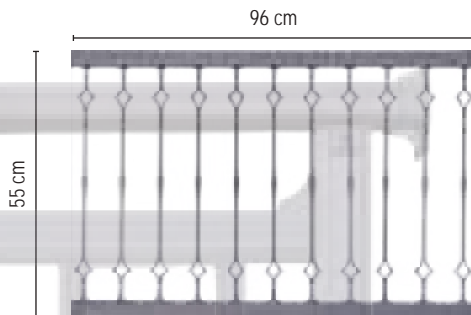

COD. 55 - 16 MOD. ESTRELLA B

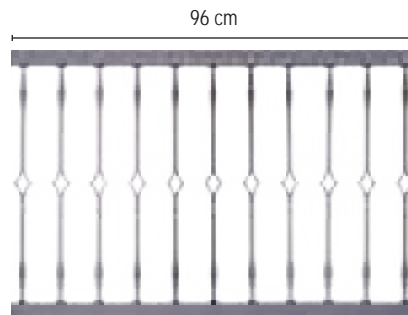

COD. 55 - 17 MOD. ESTRELLA A

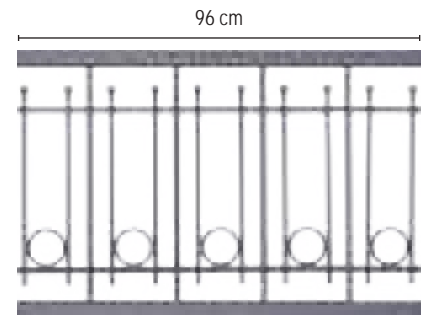

COD. 55 - 18 MOD. KIKLADES



Altura para barandilla entre 80-97 cm

ALTURA 70 cm

96 cm

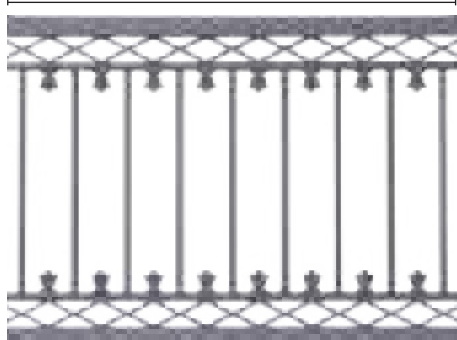

COD. 70 - 01 MOD. KOLONATO

96 cm

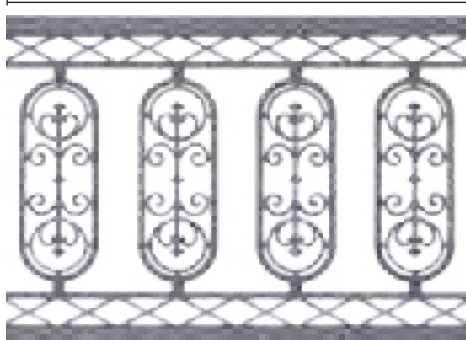

COD. 70 - 04 MOD. CORONA CON ROMBO

84 cm

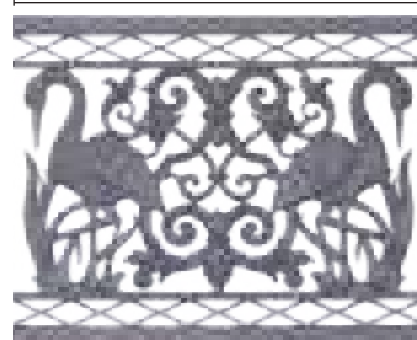

COD. 70 - 05 MOD. GARZAS CON ROMBO

70 cm

96 cm



COD. 70 - 06 MOD. DRAGONES CON ROMBO

84 cm

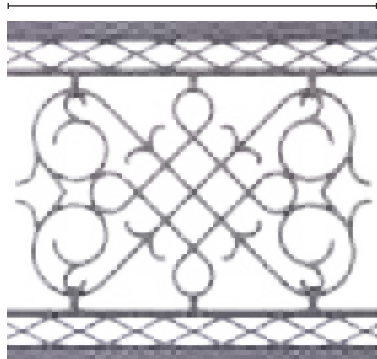

COD. 70 - 07 MOD. BIZANTINO CON ROMBO

96 cm



COD. 70 - 10 MOD. TRAZADO

70 cm

96 cm

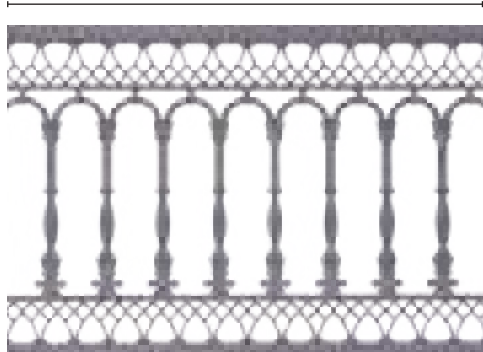

COD. 70 - 12 MOD. KAMARA

96 cm

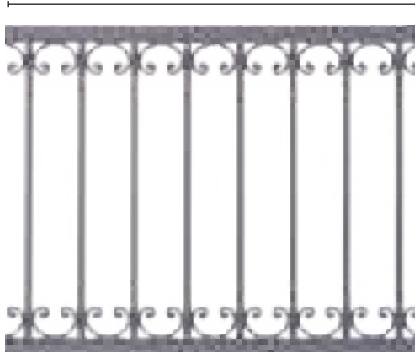

COD. 70 - 13 MOD. MACRIGIANNI

96 cm

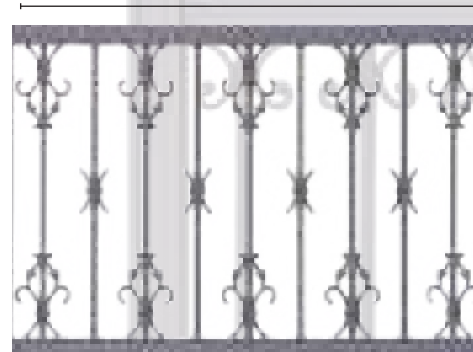

COD. 70 - 14 MOD. DELFIN

70 cm

47 cm



COD. 70 - 15 MOD. VENEZIANO

78 cm

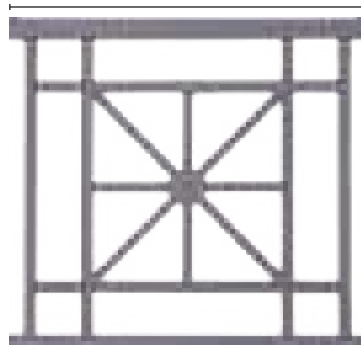

COD. 70 - 16 MOD. CLASICO

77 cm



COD. 70 - 17 MOD. DORICO

70 cm

ALTURA 70 cm

Altura para barandilla entre 80-97 cm

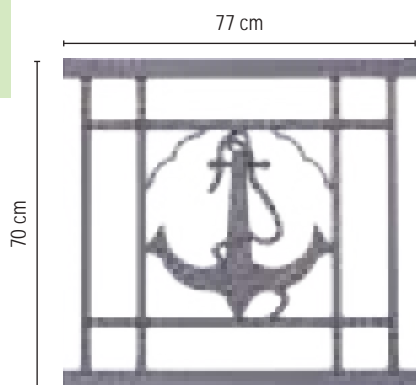

COD. 70-18 MOD. ANCLA

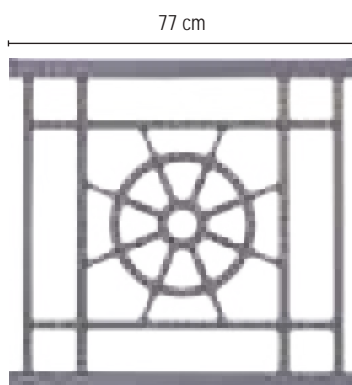

COD. 70-19 MOD. TIMON

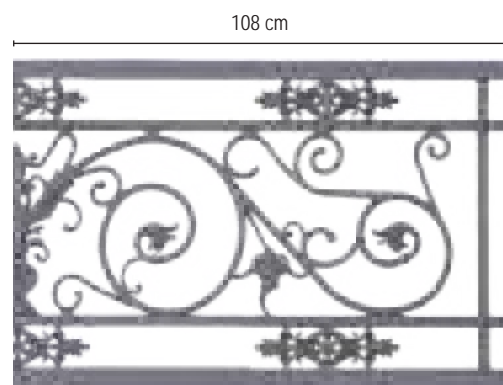

COD. 70-20 MOD. PERICLOCADA

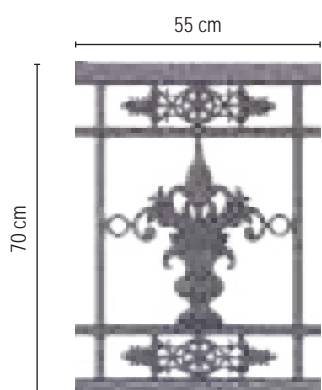

COD. 70-21 MOD. GLASTRA

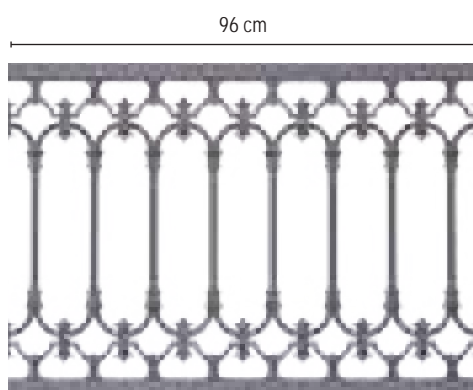

COD. 70-24 MOD. VIENES

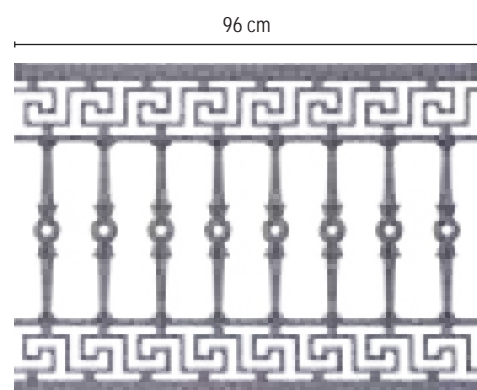

COD. 70-25 MOD. ATENIENSE

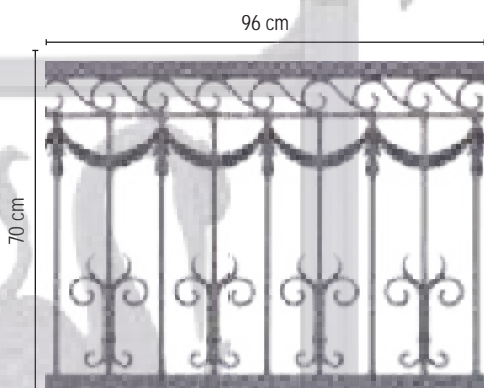

COD. 70-26 MOD. GIRNALDA

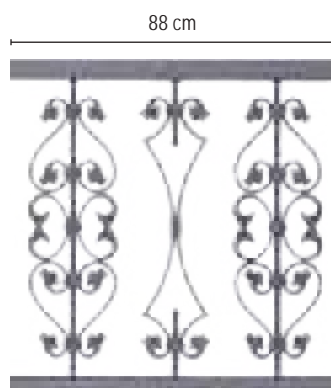

COD. 70-27 MOD. CARAVOLO

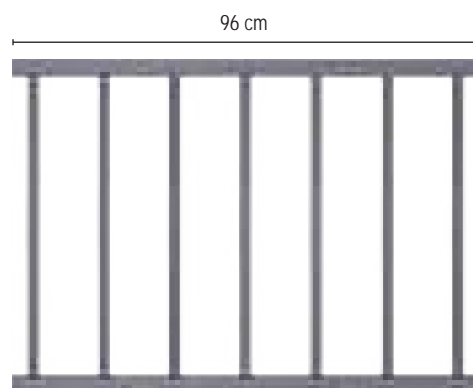

COD. 70-28 MOD. LINEAL
SISTEMA LINEAL ABROCHADO
El sistema está patentado - N° Patente: 20000200038

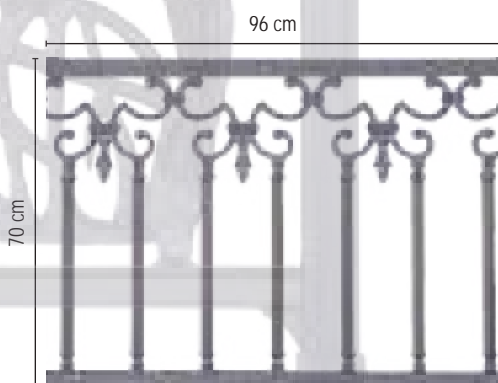

COD. 70-29 MOD. KNOSOS

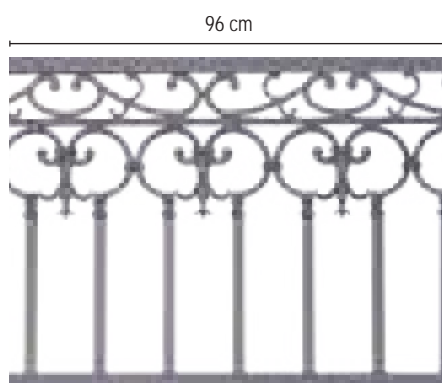

COD. 70-30 MOD. FESTOS

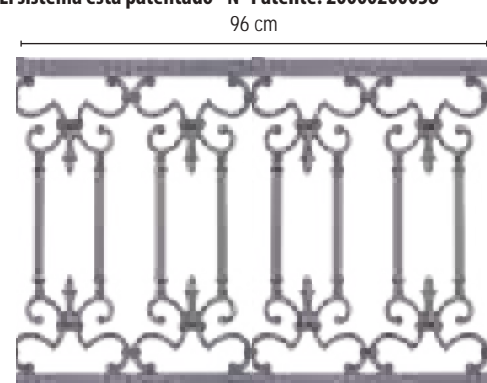

COD. 70-31 MOD. KNOSOS B

Altura para barandilla entre 80-97 cm

ALTURA 70 cm

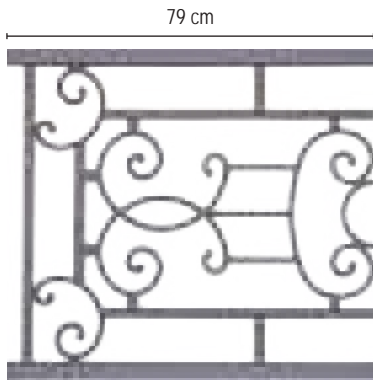

COD. 70-32 MOD. OLIMPIA

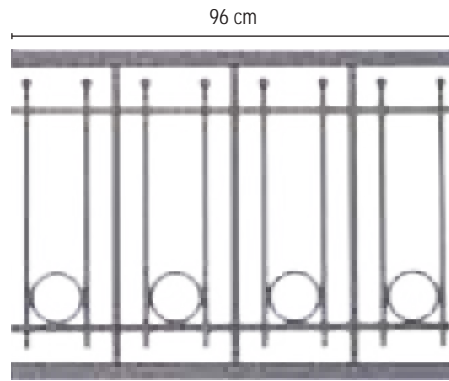

COD. 70-33 MOD. KIKLADES

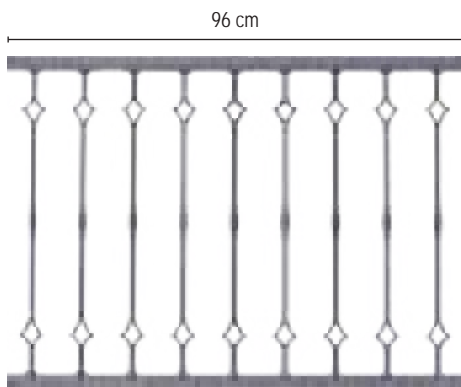

COD. 70-34 MOD. ESTRELLA B

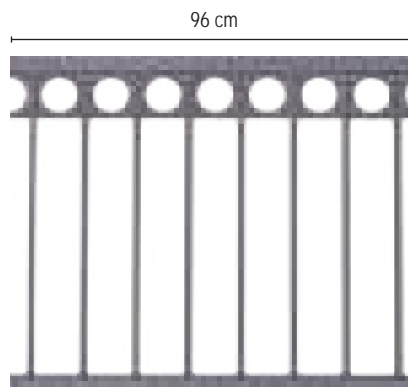

COD. 70-35 MOD. SERIFO

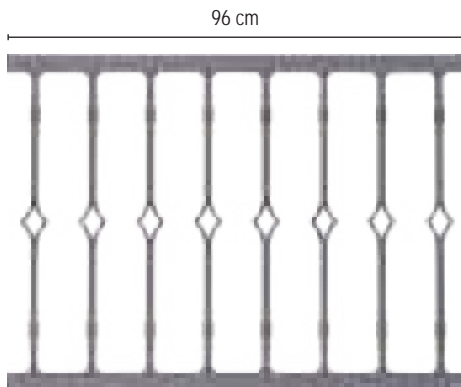

COD. 70-36 MOD. ESTRELLA A

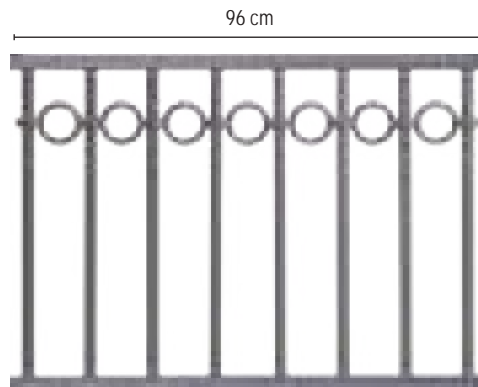

COD. 70-37 MOD. OLYMPIC

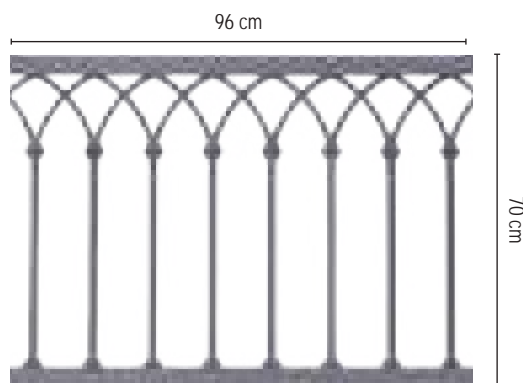

COD. 70-38 MOD. GOTICO

70 cm

70 cm

70 cm

70 cm

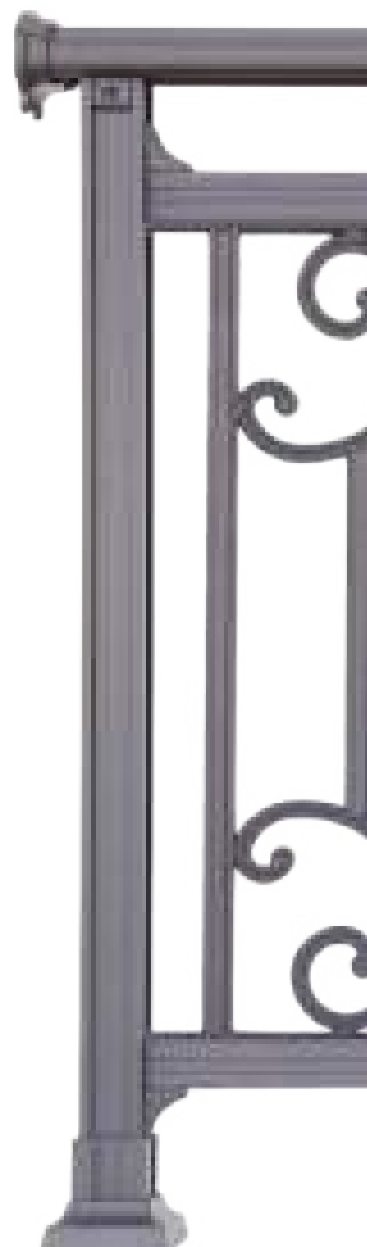

ALTURA 80 cm

Altura para barandilla entre 90-107 cm

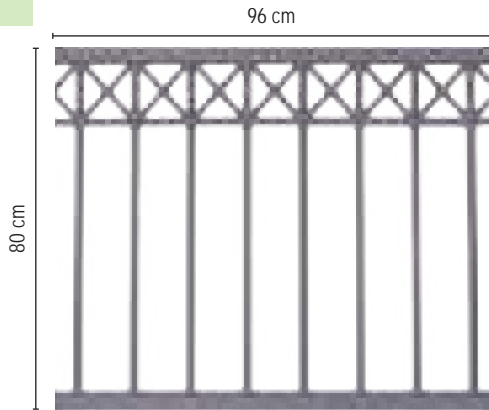

COD. 80 - 01 MOD. INTERNACIONAL
96 cm

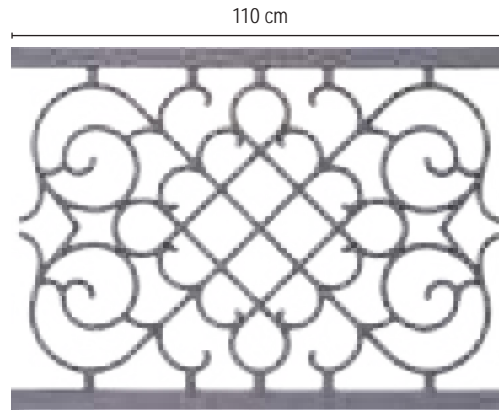

COD. 80 - 02 MOD. BIZANTINO
96 cm

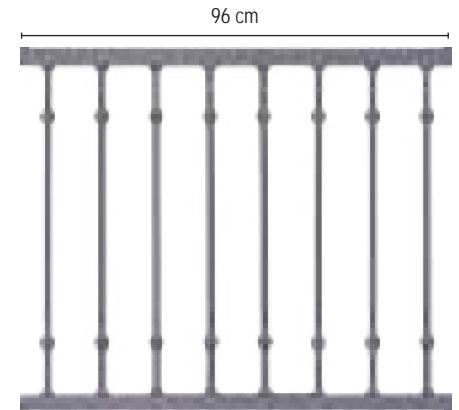

COD. 80 - 03 MOD. LINEAL
96 cm

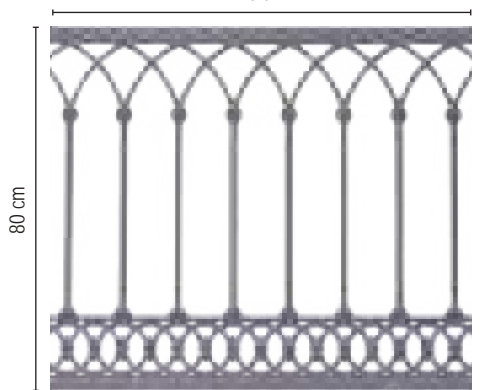

COD. 80 - 04 MOD. GOTICO

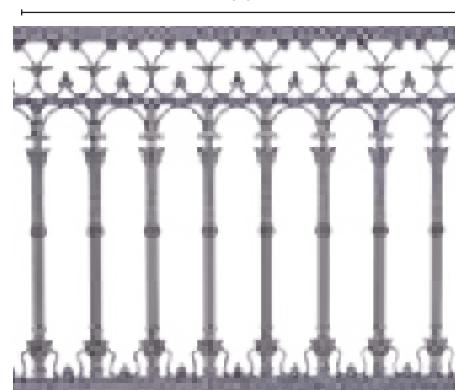

COD. 80 - 05 MOD. COLONIAL



COD. 80 - 06 MOD. LINEAL ABROCHADO

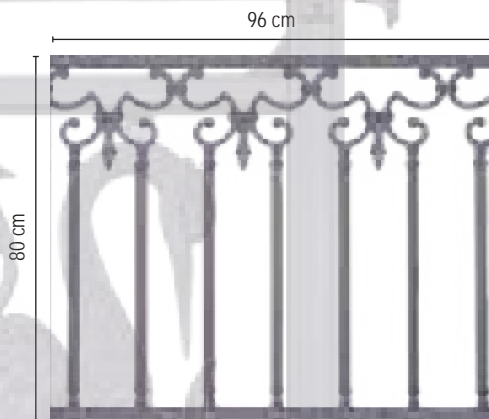

COD. 80 - 07 MOD. KNOSOS

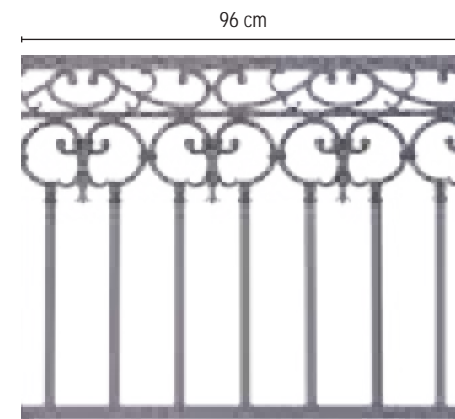

COD. 80 - 08 MOD. FESTOS

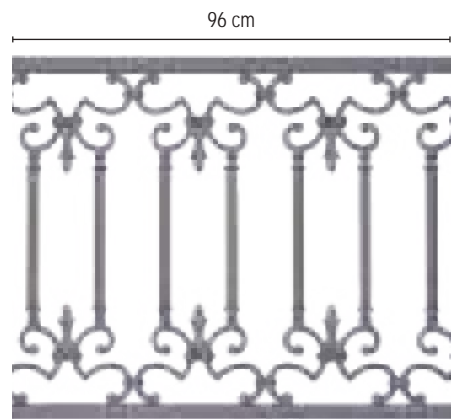

COD. 80 - 09 MOD. KNOSOS B

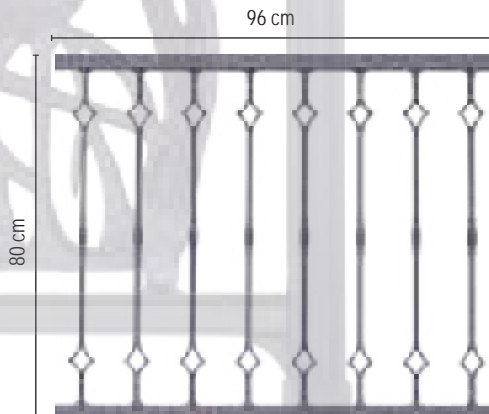

COD. 80 - 10 MOD. ESTRELLA B

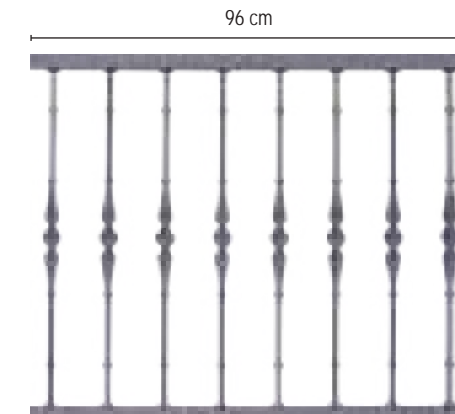

COD. 80 - 11 MOD. MINOAN A

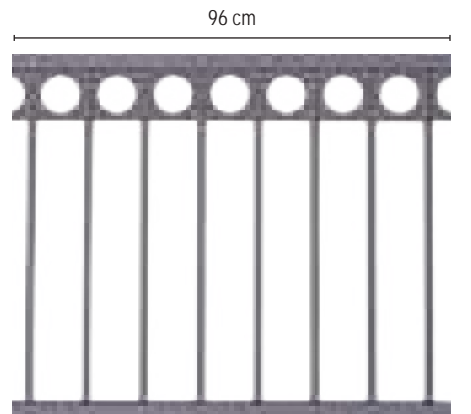

COD. 80 - 13 MOD. SERIFO

Altura para barandilla entre 90-107 cm

ALTURA 80 cm

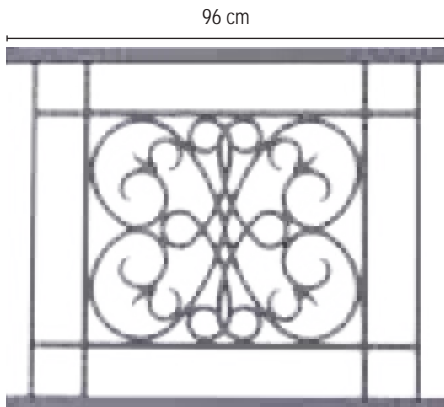

COD. 80 - 14 MOD. EFESSOS
96 cm

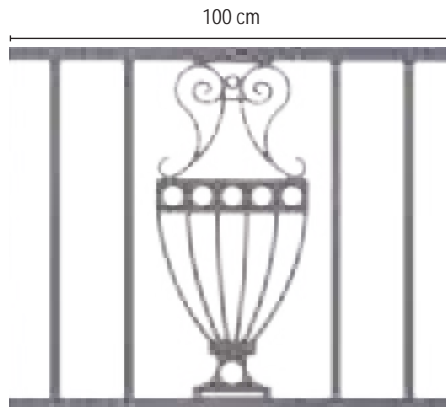

COD. 80 - 15 MOD. COPA
96 cm

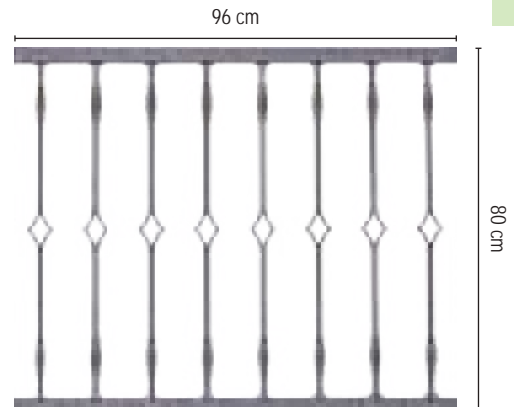

COD. 80 - 18 MOD. ESTRELLA A
96 cm

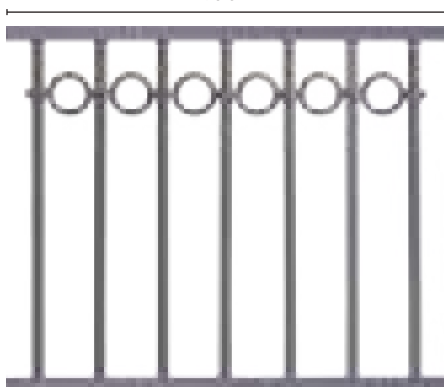

COD. 80 - 19 MOD. OLYMPIC
96 cm

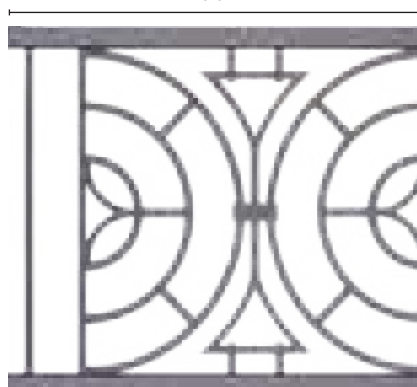

COD. 80 - 20
96 cm

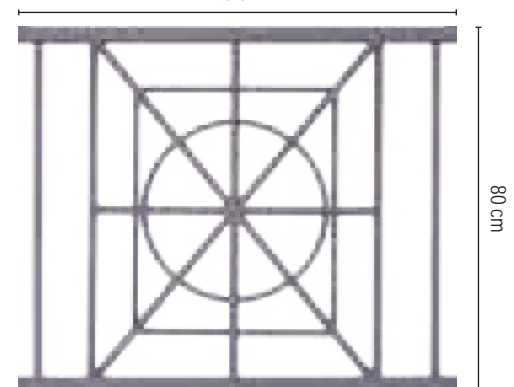

COD. 80 - 21 MOD. GEOMETRICO
96 cm

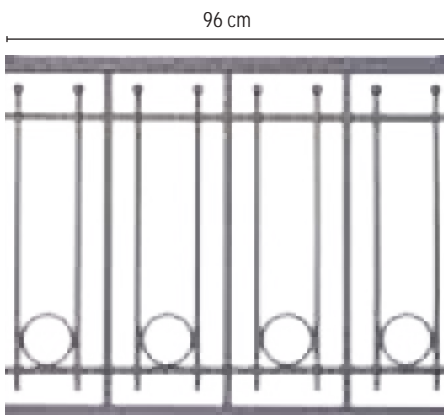

COD. 80 - 22 MOD. KIKLADES
96 cm

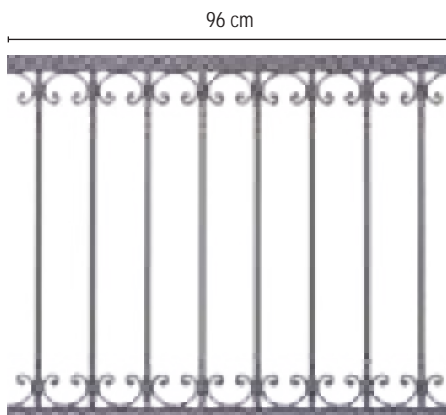

COD. 80 - 23 MOD. MACRIGIANNI
96 cm

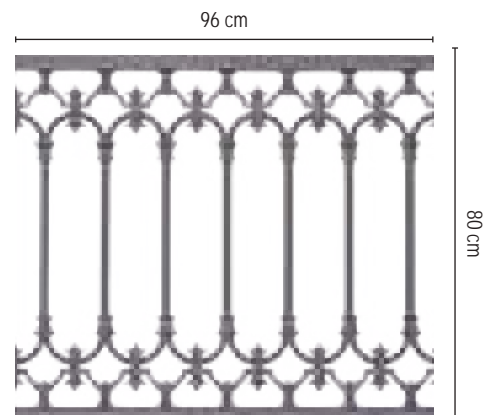

COD. 80 - 24 MOD. VIENES
96 cm



COD. 80 - 25 MOD. VENECIANO
47 cm

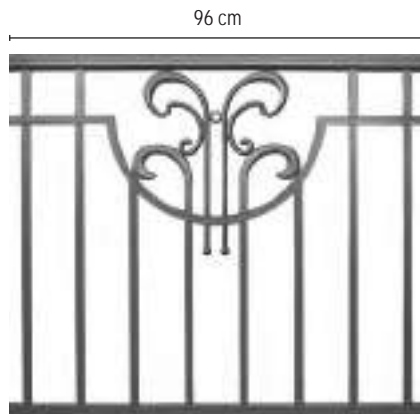

COD. 80 - 27
96 cm

*** Todos nuestros productos se pueden cortar y soldar a la medida deseada**

SISTEMA DE BARANDILLA AL - FLEX



PARA BALCONES Y ESCALERAS

ALTURA **55 cm**

Todas las piezas **al - flex** que tienen las mismas medidas, se pueden combinar entre ellas.

Todas las piezas **al - flex serie 55** tienen 55cm de altura y son adecuados para la fabricación de barandillas con una altura final:

mínimo 67 cm.
máximo 85 cm.

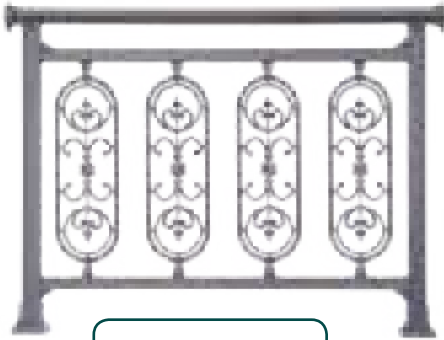

COD. 55 - 30

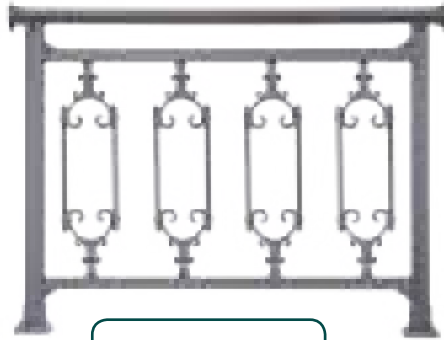

COD. 55 - 31

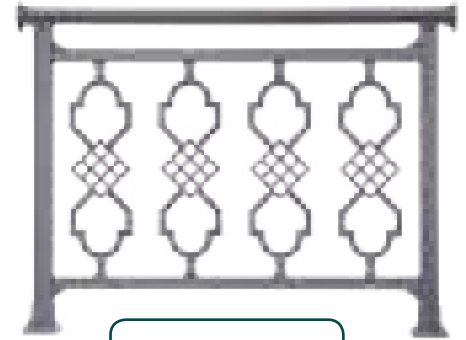

COD. 55 - 32

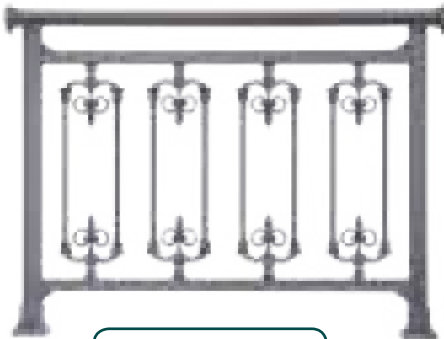

COD. 55 - 33

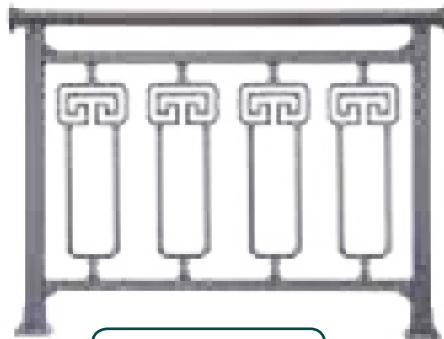

COD. 55 - 34

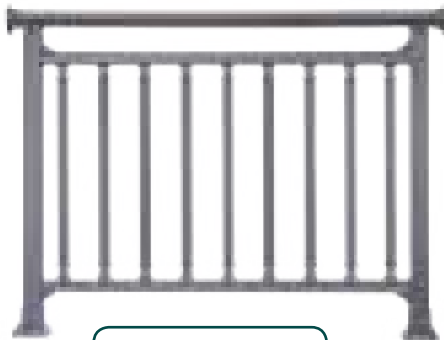

COD. 55 - 35

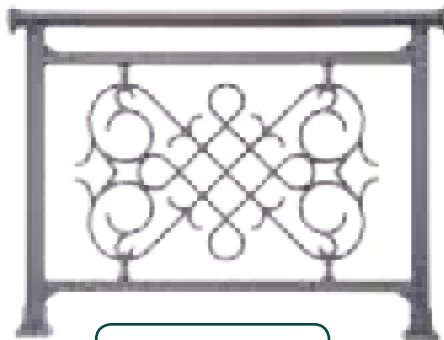

COD. 55 - 36

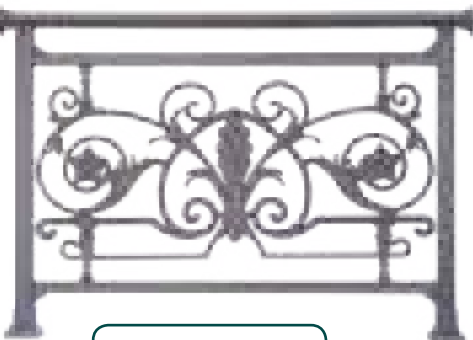

COD. 55 - 37

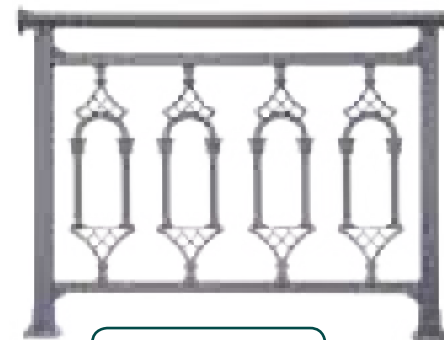

COD. 55 - 38

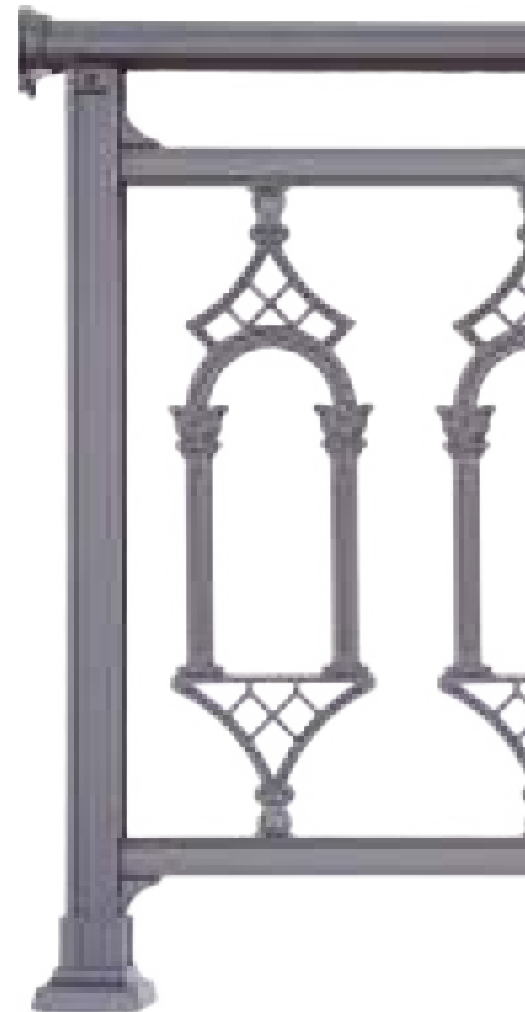

ALTURA 55 cm

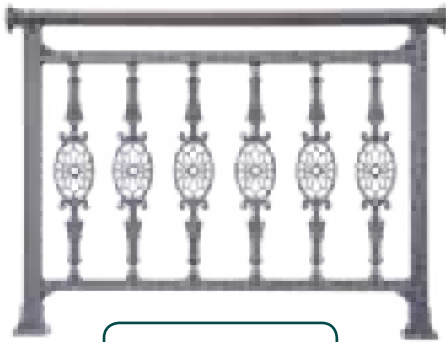

COD. 55 - 39

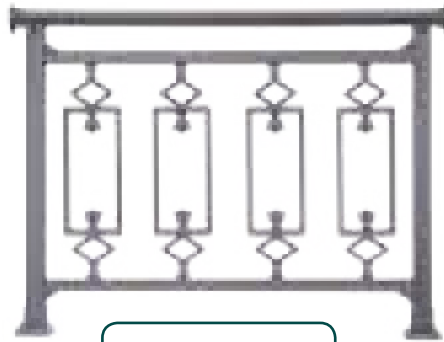

COD. 55 - 40

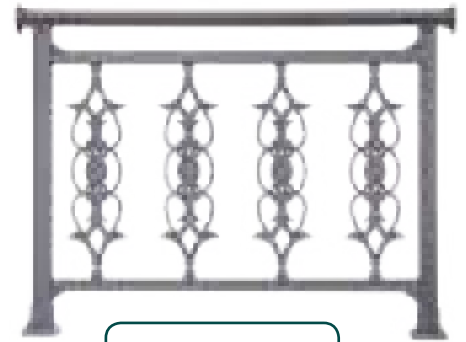

COD. 55 - 41

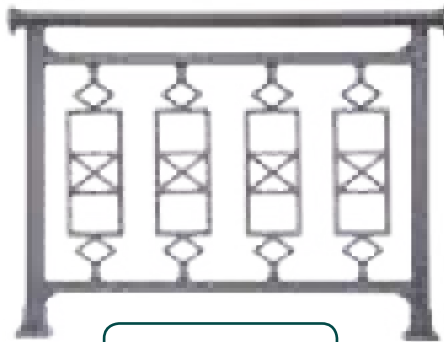

COD. 55 - 42

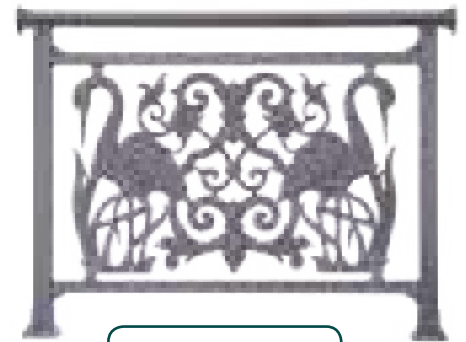

COD. 55 - 43

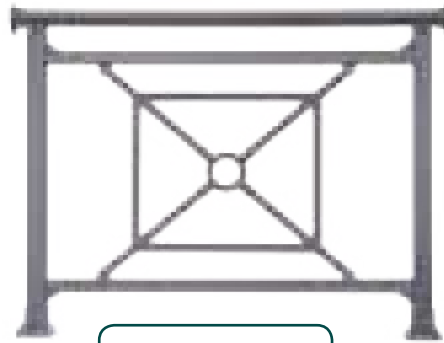

COD. 55 - 44

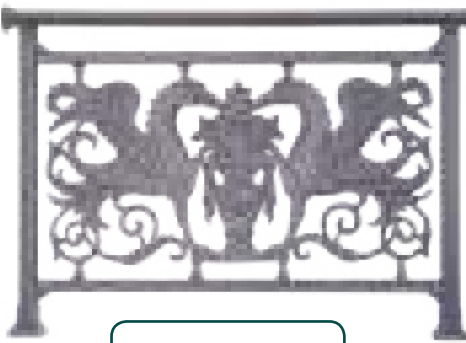

COD. 55 - 45

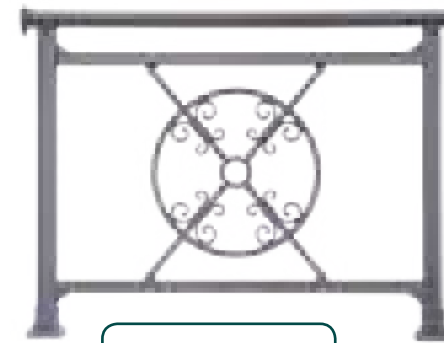

COD. 55 - 46

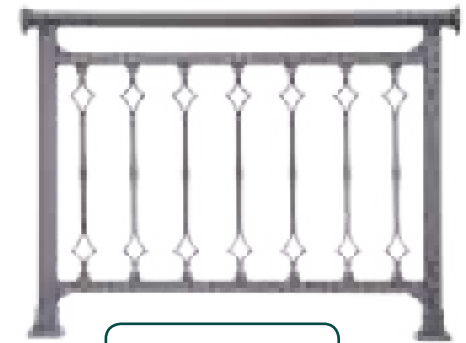

COD. 55 - 47



ALTURA 65 cm

Todas las piezas **al - flex** que tienen las mismas medidas, se pueden combinar entre ellas.

Todas las piezas **al - flex serie 65** tienen 65cm de altura y son adecuados para la fabricación de barandillas con una altura final:

mínimo 77 cm.
máximo 95 cm.

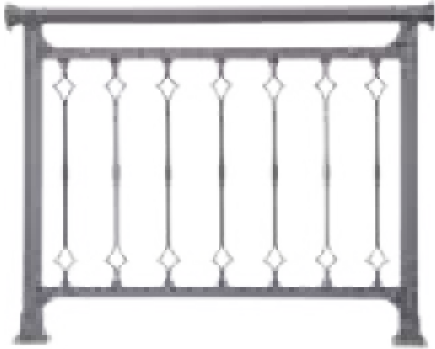

COD. 65 - 30

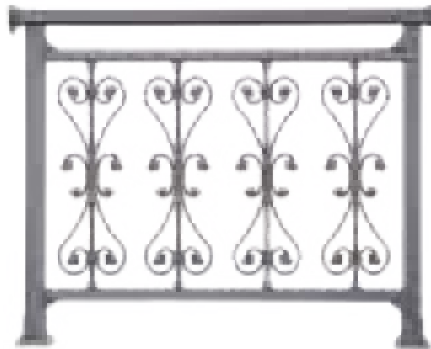

COD. 65 - 31



COD. 65 - 32



COD. 65 - 33

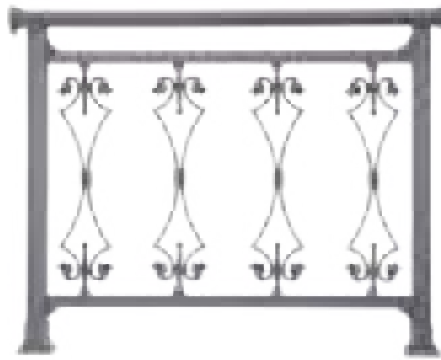

COD. 65 - 34



COD. 65 - 35

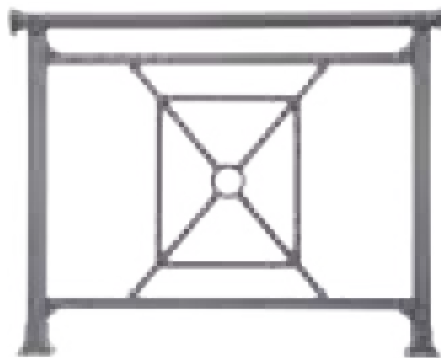

COD. 65 - 36

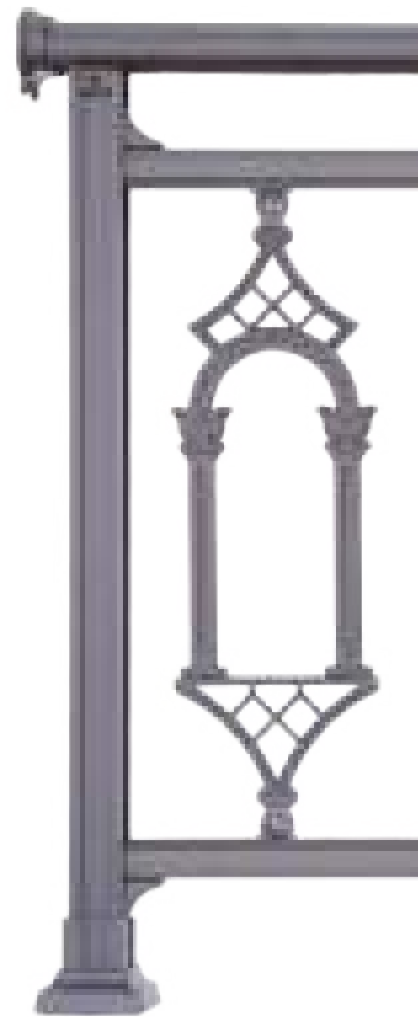

ALTURA 65 cm

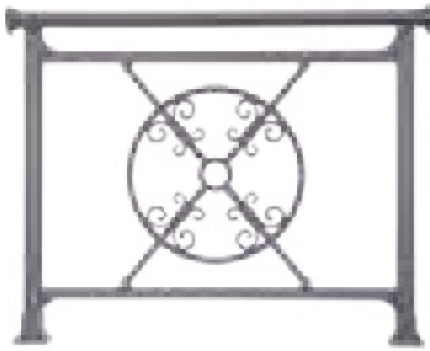

COD. 65 - 37

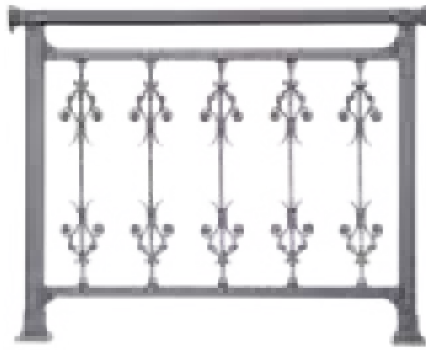

COD. 65 - 38

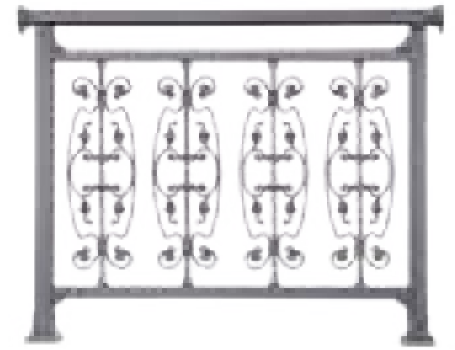

COD. 65 - 39

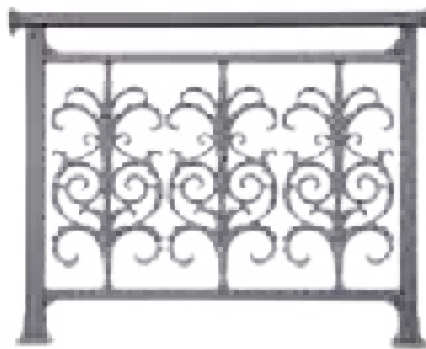

COD. 65 - 41

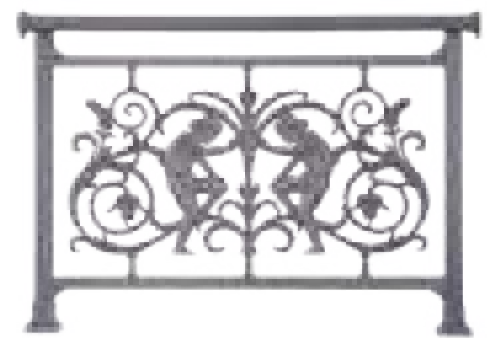

COD. 65 - 42

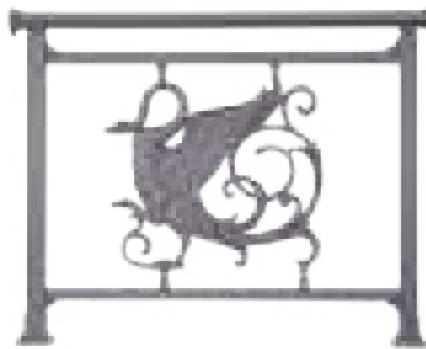

COD. 65 - 43



COD. 65 - 44

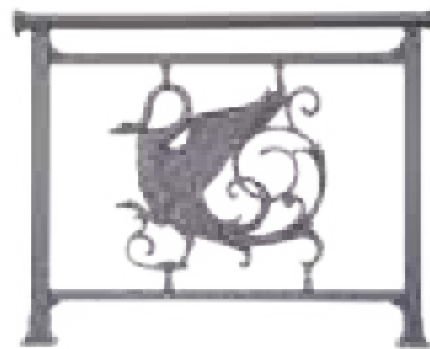

COD. 65 - 45



ALTURA 75 cm

Todas las piezas **al - flex** que tienen las mismas medidas, se pueden combinar entre ellas.

Todas las piezas **al - flex serie 75** tienen 75cm de altura y son adecuados para la fabricación de barandillas con una altura final:

mínimo 87 cm.
máximo 105 cm.



COD. 75 - 30

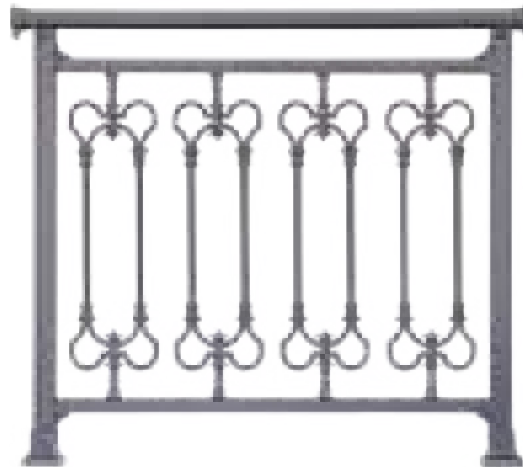

COD. 75 - 31

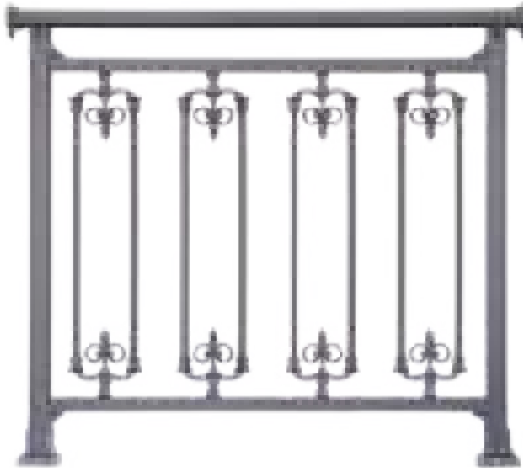

COD. 75 - 32

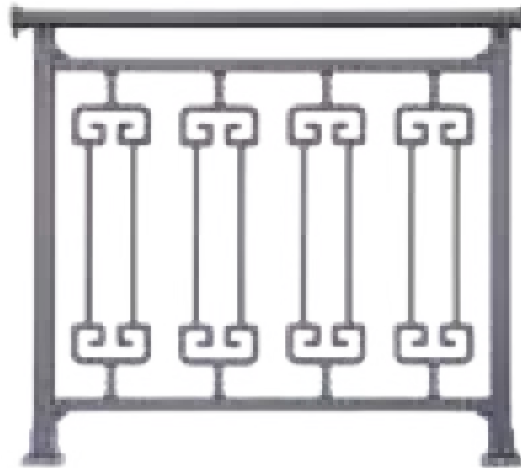

COD. 75 - 33



COD. 75 - 34

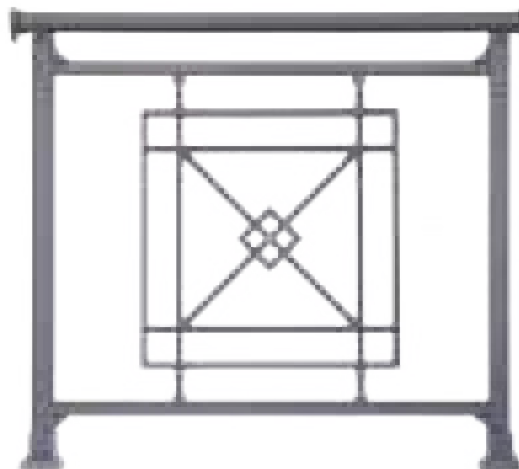

COD. 75 - 35

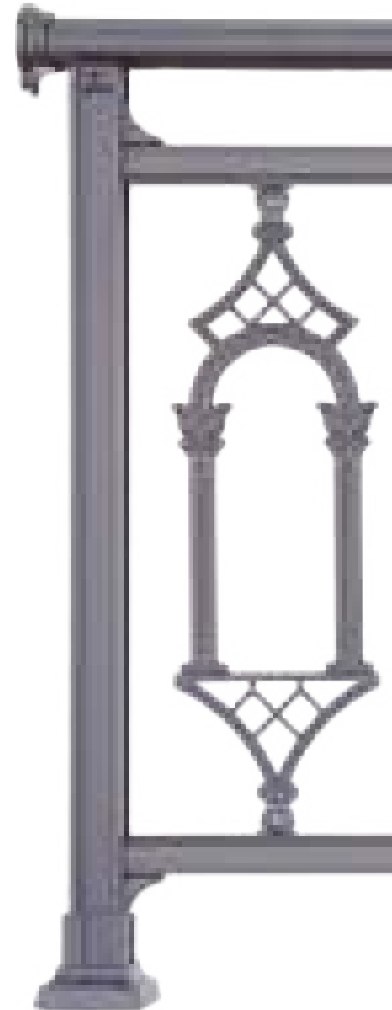

ALTURA 75 cm

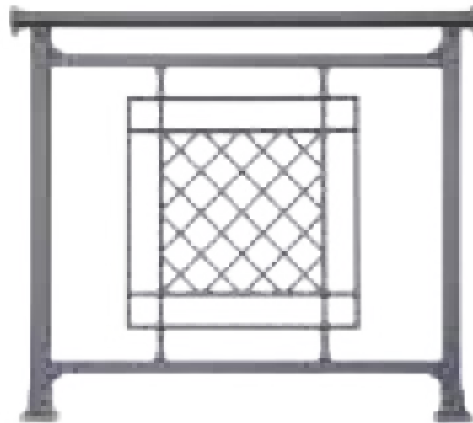

COD. 75 - 36

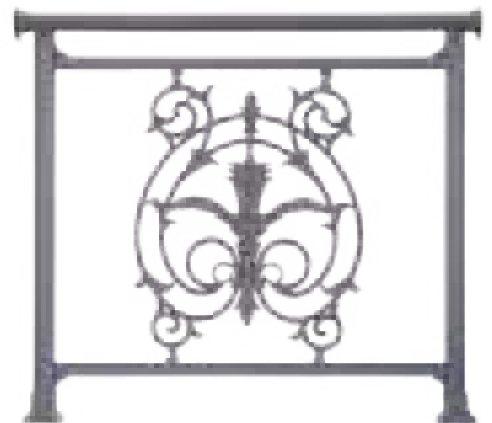

COD. 75 - 37

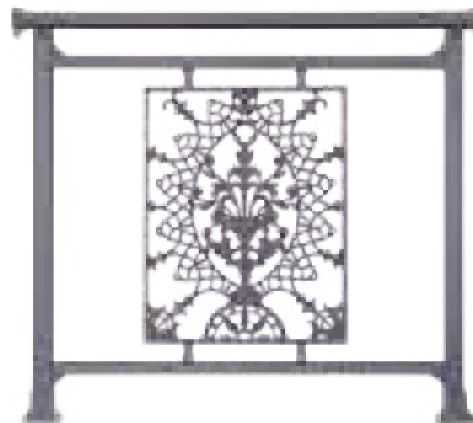

COD. 75 - 38

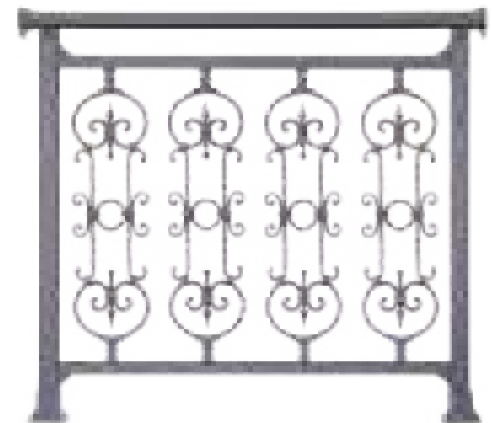

COD. 75 - 39

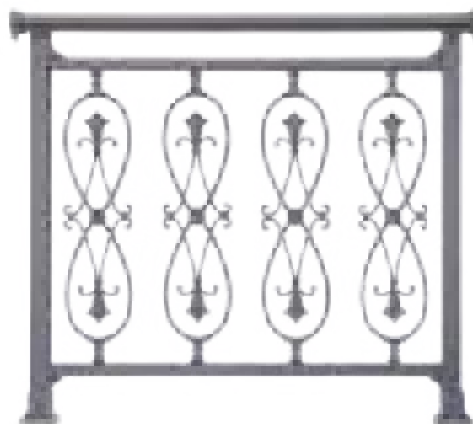

COD. 75 - 40



COD. 75 - 42

ALTURA 85 cm

Todas las piezas **al - flex** que tienen las mismas medidas, se pueden combinar entre ellas.

Todas las piezas **al - flex serie 85** tienen 85cm de altura y son adecuados para la fabricación de barandillas con una altura final:

mínimo 97 cm.
máximo 115 cm.

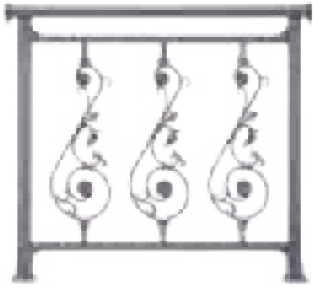

COD. 85 - 30

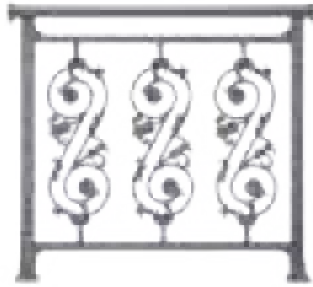

COD. 85 - 31

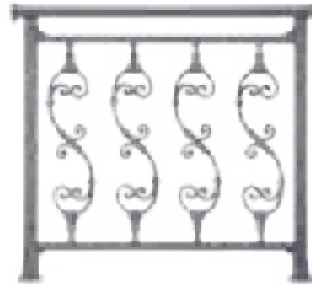

COD. 85 - 32

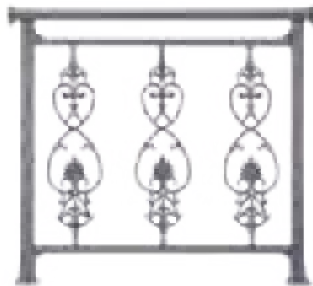

COD. 85 - 33

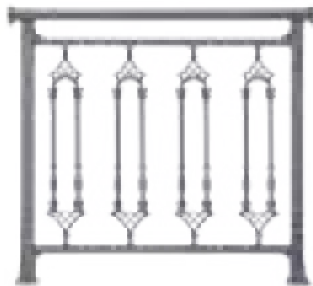

COD. 85 - 34

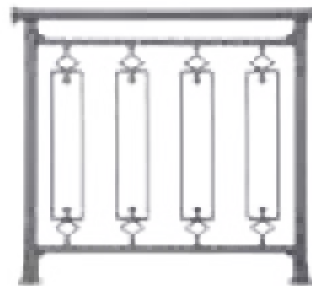

COD. 85 - 35

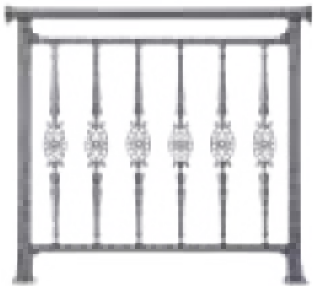

COD. 85 - 36

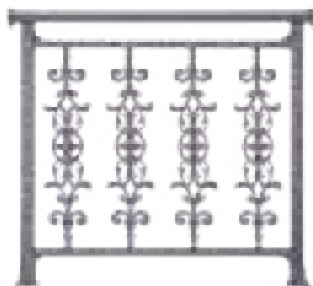

COD. 85 - 37



COD. 85 - 38

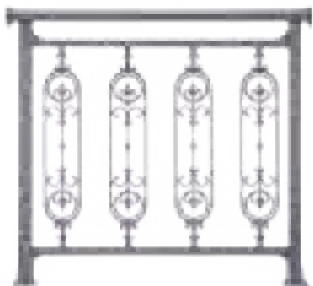

COD. 85 - 39

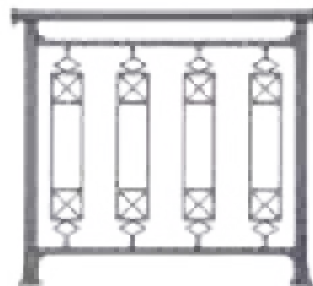

COD. 85 - 40

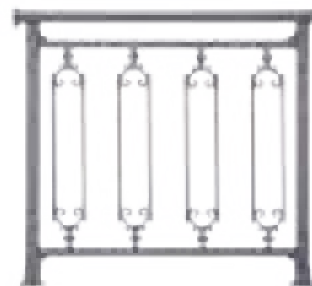

COD. 85 - 41

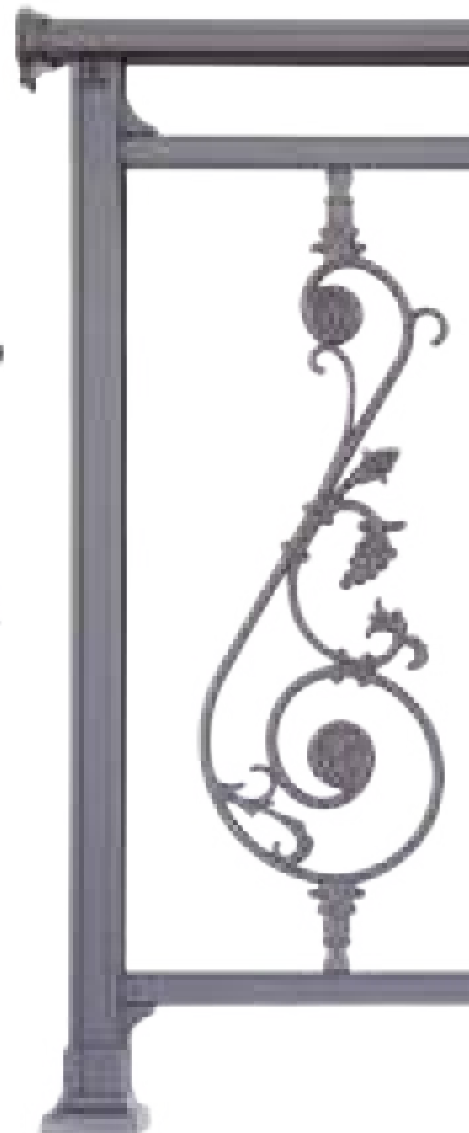

ALTURA 85 cm

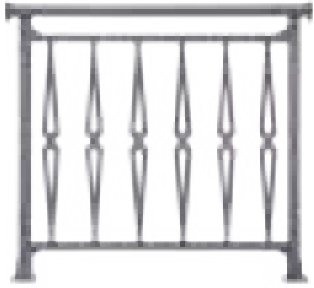

COD. 85 - 42

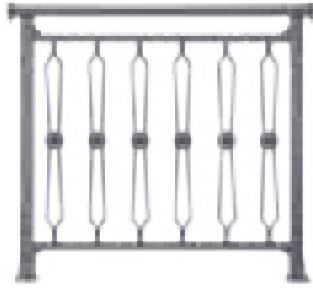

COD. 85 - 43



COD. 85 - 44



COD. 85 - 45



COD. 85 - 46

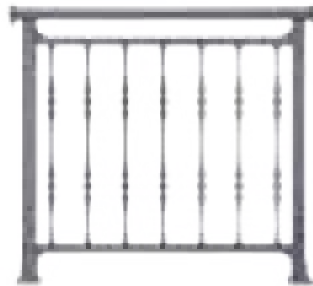

COD. 85 - 47

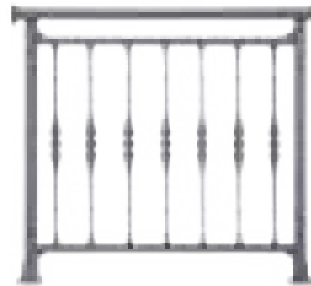

COD. 85 - 48



COD. 85 - 49



COD. 85 - 50

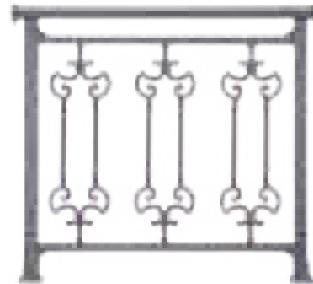

COD. 85 - 51

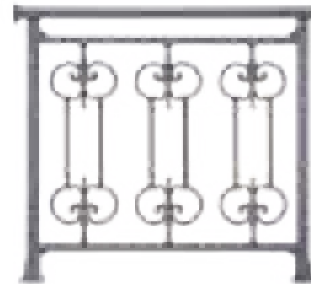

COD. 85 - 52



COD. 85 - 53



COD. 85 - 54



COD. 85 - 55

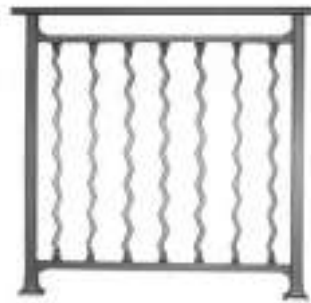

COD. 85 - 56



COD. 85 - 57

**NUEVO SISTEMA LINEAL
PARA BARANDILLAS Y ESCALERAS**

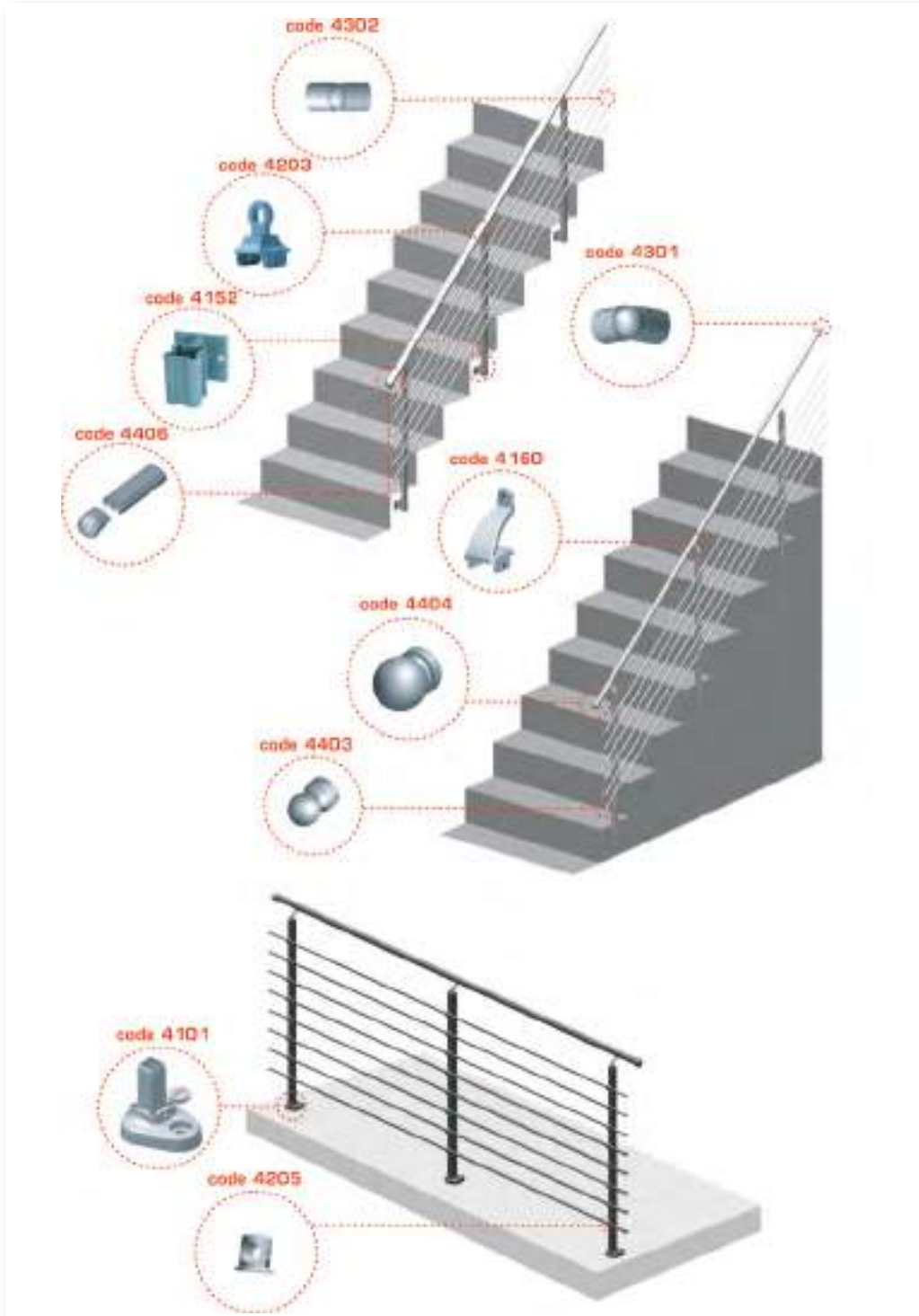

AVANT GARDE STAIRS



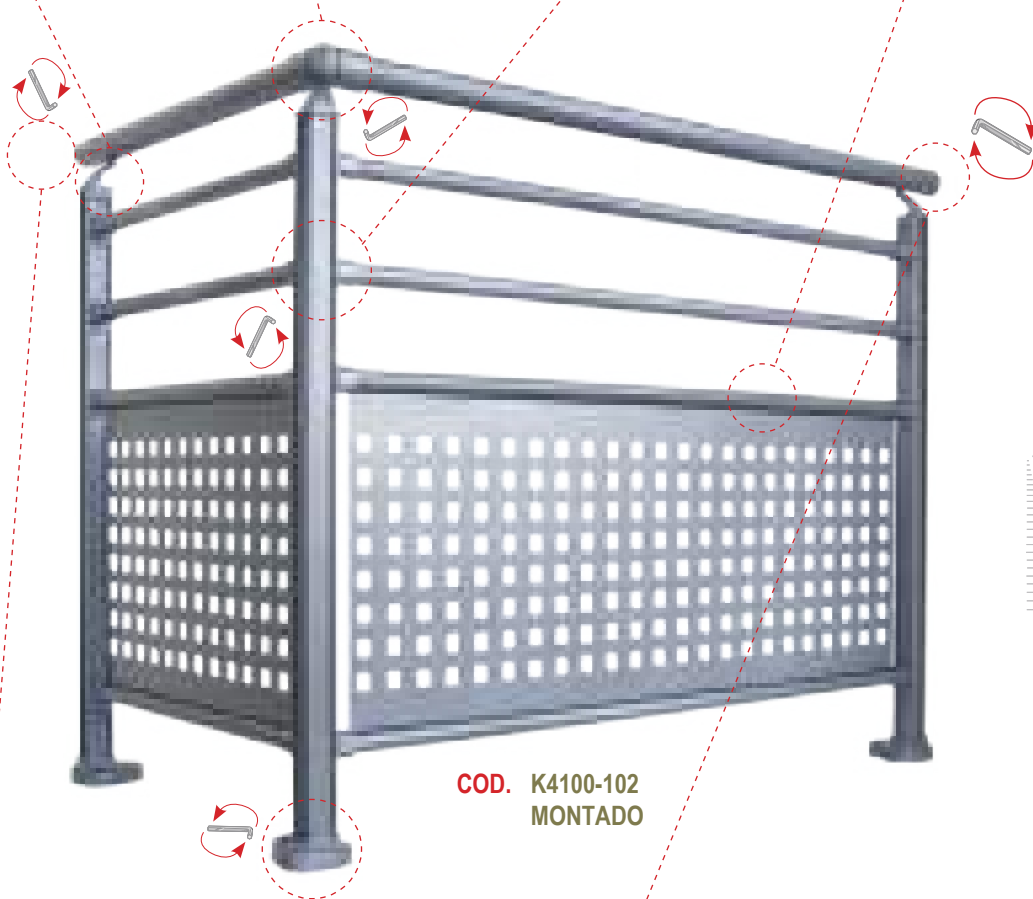
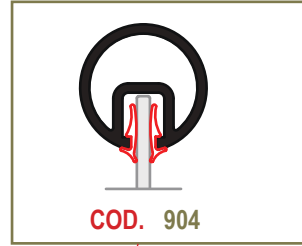

COD. K4100-102 MONTADO

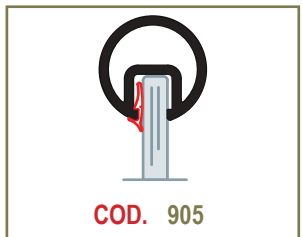

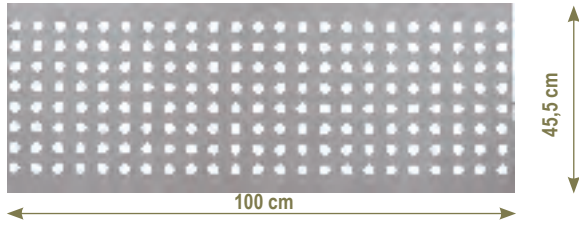

COD. L4501

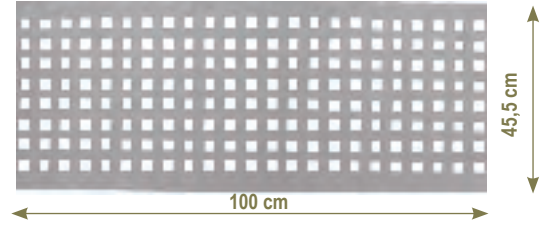

COD. L4502



COD. 920
F-H2 Pasamanos

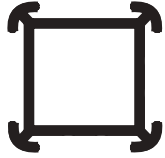

COD. 915
Columna



COD. 6-001
F-26 Rail horizontal



COD. 904
Sujeción para chapa de aluminio o inox entre 2 y 3 mm



COD. 905
F-26 Para cristal 6mm



COD. 952
F-26 Para cristal 10mm



COD. 410-420
Junta de goma



COD. 4109
Pie de sujeción cod. 915



COD. 4150
Pie exterior columna 915



COD. 4151
Pie exterior columna 915



COD. 4152
Pie exterior columna 915



COD. 4203
Union columna-pasamanos



COD. 4160
Union columna-pasamanos 920



COD. 4161
Union columna-pasamanos 920 esquina



COD. 4301
Union columna-pasamanos 920 articulado



COD. 4155
Sujeción a pared pasamanos 920



COD. 4401
Tapa de pasamanos 920



COD. 4501
Acabado pared para pasamanos 920



COD. 4202
Union columna-rail F26



COD. 904
Union articulada para escalera F26



CANCELAS

PUERTAS DE
ALUMINO

REFORZADAS
CON
SOLDADURA



Diseño personalizado en puertas y vallas de
jardín incorporando cualquiera de nuestros
modelos del catálogo



COD. 1



COD. 2



COD. 3

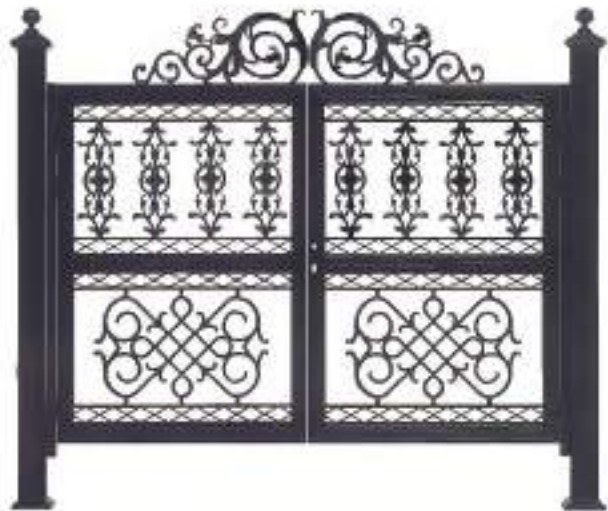

COD. 4



COD. 5



COD. 6



COD. 7



COD. 8



COD. 9



COD. 10



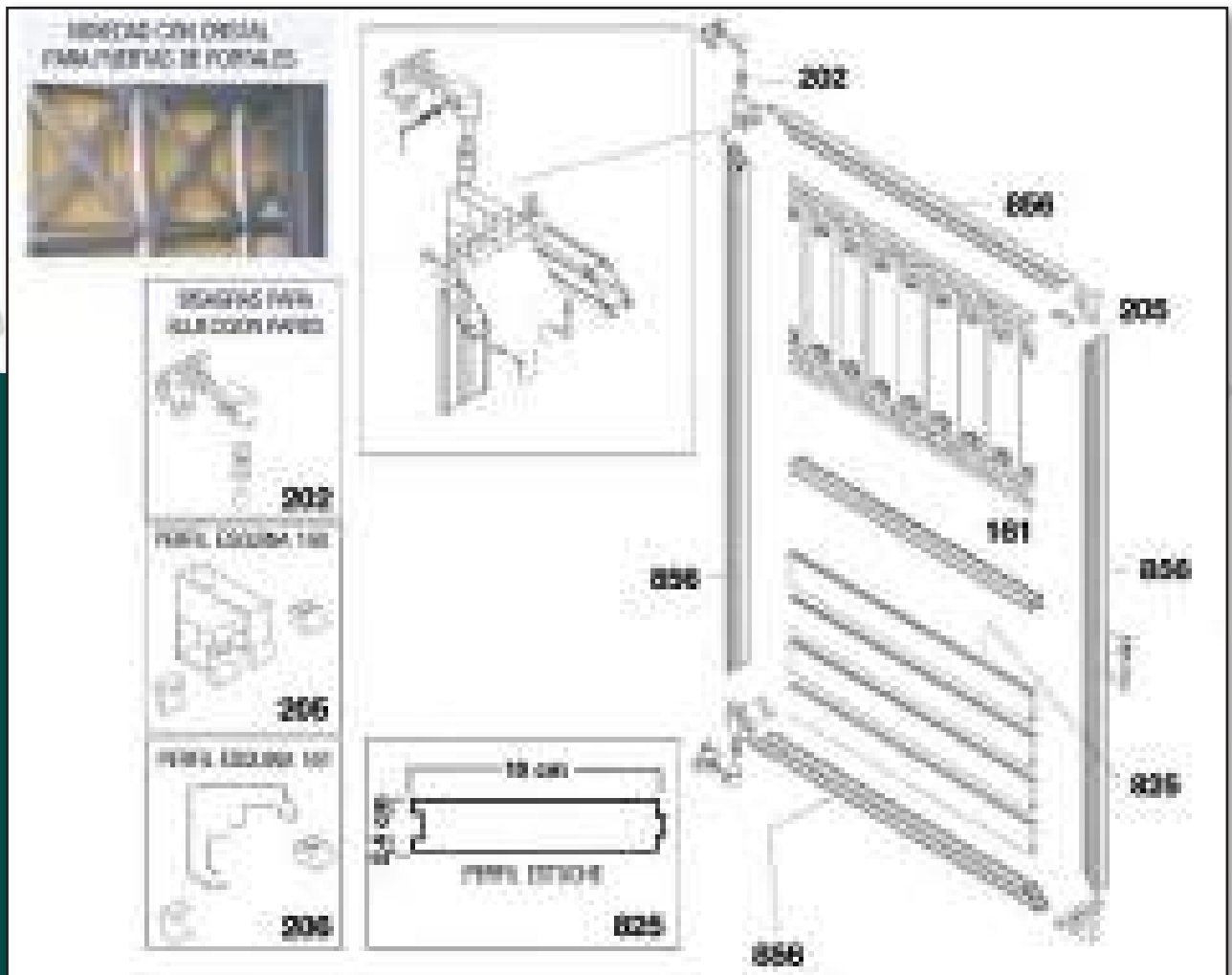

ALTURA 19 cm



14 - 05 : ROMBO



15 - 03 : KIMATAKI

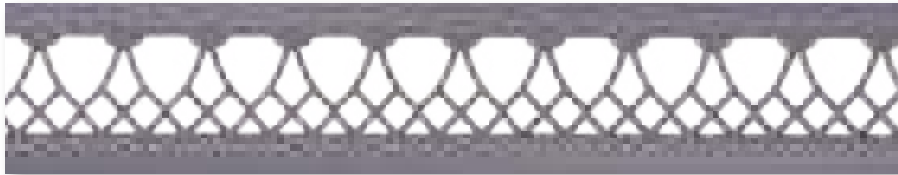

16 - 04 : CAMARA

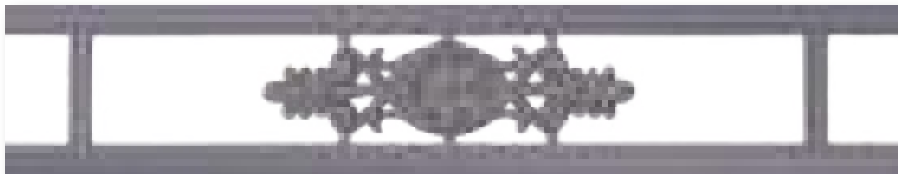

17 - 07 : ROSETA

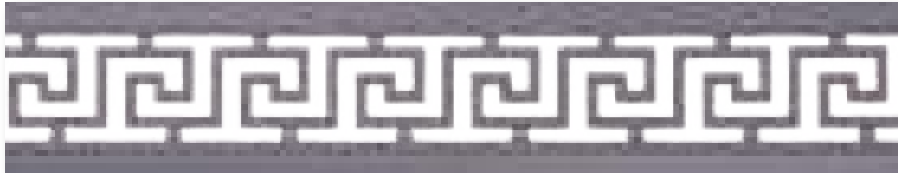

18 - 01 : MEANDROS

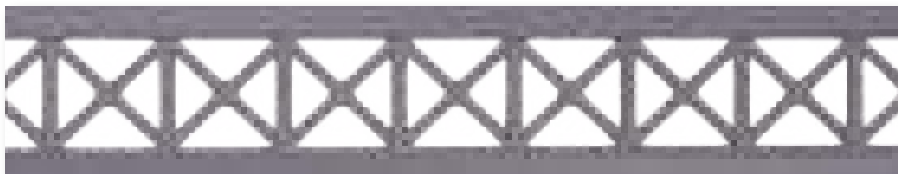

19 - 02 : NACIONAL

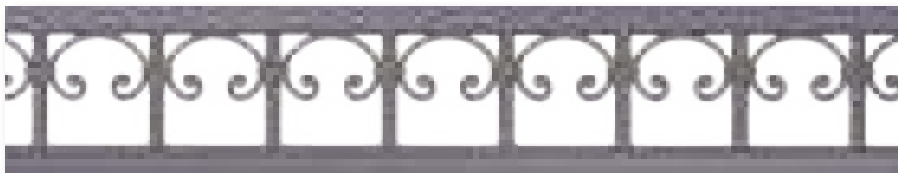

19 - 06 : MACRIGIANI

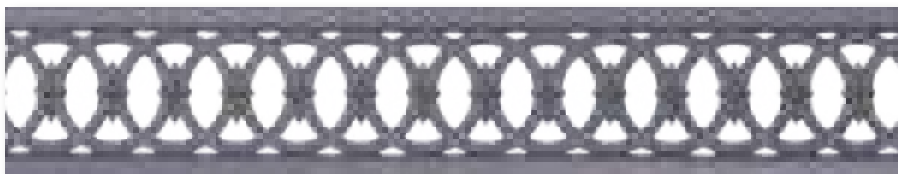

19 - 09 : GOTICO

Módulos Flechas Aluminco / Vallas y Puertas

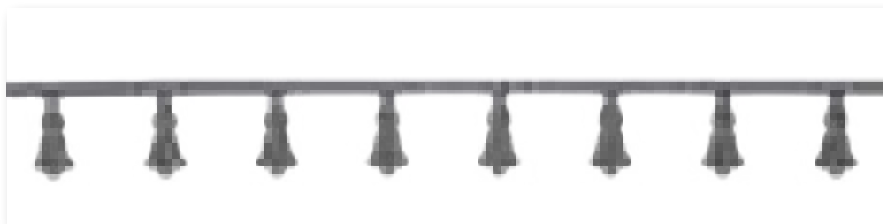

96 x 13cm

COD. 13-13 - CAMPANAS

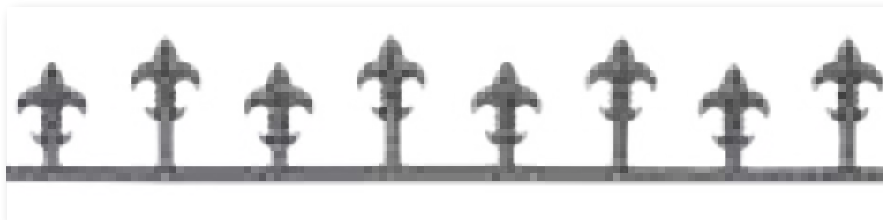

96 x 16cm

COD. 16-11 - ACRO FLECHAS

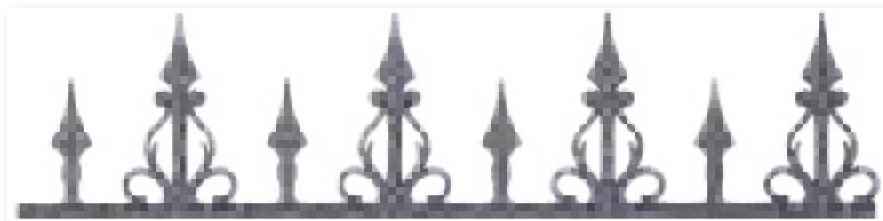

96 x 25cm

COD. 16-12 - ESPADAS

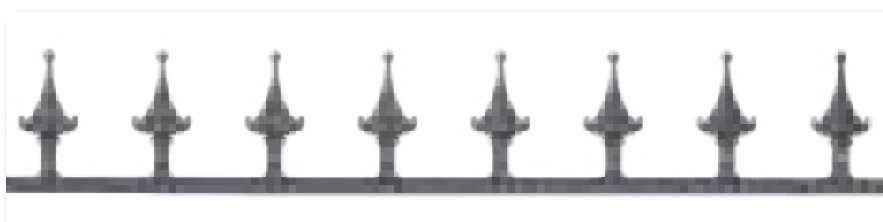

96 x 19cm

COD. 19-10 - DORY

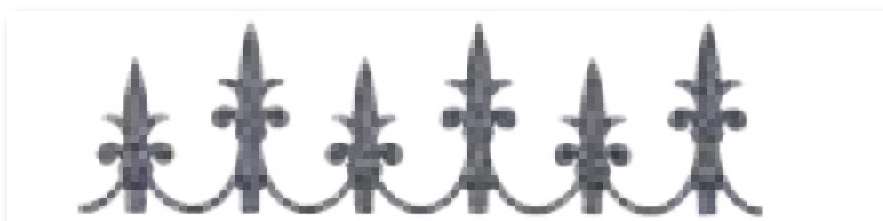

76 x 19cm

COD. 239



6,3 x 9,5cm

COD. 42



1,6 x 2,5cm

COD. 45



9 x 15cm

COD. 240

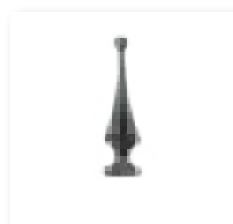

3,5 x 14cm

COD. 267



3,5 x 3,5cm

COD. 268

Combinados de Modulos Valla

ALTURA ENTRE 85 cm HASTA 120 cm

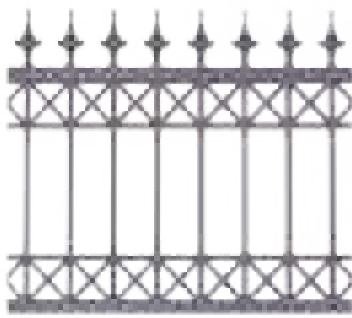

COD. 19-10+70-11

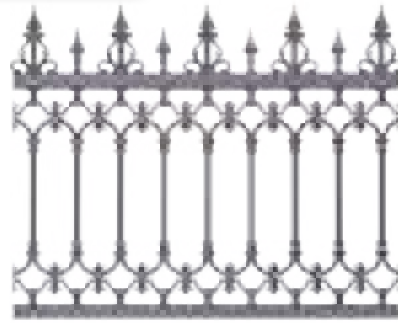

COD. 16-12+70-24

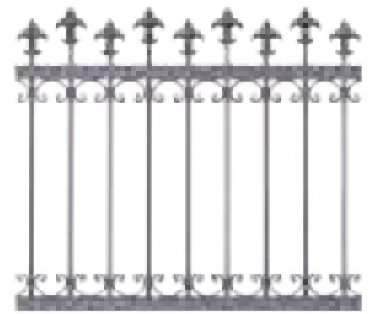

COD. 16-11+70-13

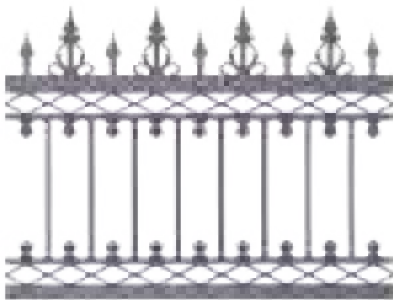

COD. 16-12+55-04



COD. 16-12+70-14+13-13

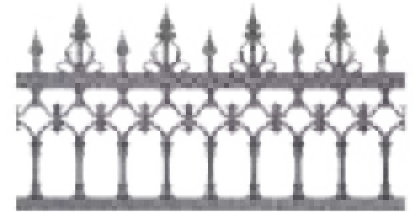

COD. 16-12+35-02

ALTURA ENTRE 85 cm HASTA 200 cm



COD. 90-02

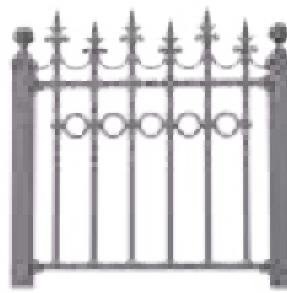

COD. 90-03



COD. 90-04



COD. 90-05

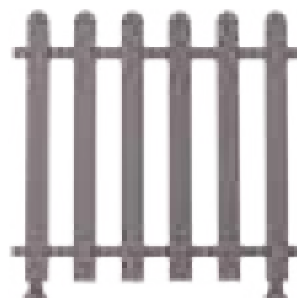

COD. 89-01



Cod. 4118	Cod. 4120	Cod. 4113	Cod. 4331	Cod. 4445	Cod. 297
SOPORTE COLUMNA 70-001	SOPORTE COLUMNA 963 Y 965	SOPORTE COLUMNA 963 Y 965	SOPORTE COLUMNA PARA PASAMANOS DE 50 Ø	TAPON DE COLUMNA 963 Y 965	TAPON DE COLUMNA DE PLASTICO 070-001

Cod. 298	Cod. 299	Cod. 300	Cod. 301	Cod. 302	Cod. 303
TAPON DE PLASTICO 070-002	TAPON CONECTOR DE PLASTICO 070-002	TAPON DE PLASTICO REMATE 070-004	TAPON DE PLASTICO REMATE 070-005	TAPON DE PLASTICO REMATE 29-008	TAPON DE PLASTICO REMATE 59-010



Cod. 070-001	Cod. 963	Cod. 965	Cod. 070-002
COLUMNA EN FORMA DE "H"	COLUMNA CON TAPA TRASERA	COLUMNA CON TAPA EN 2 LATERALES	Cod. 070-004
			Cod. 070-005
			Cod. 59-10
Cod. 29-047	Cod. 510-918	Cod. 070-0K4	Cod. 29-008
COLUMNA 4 X 4 X 1,5 CM	PERFIL DE CONEXIÓN DE 070-004	PERFIL DE REMATE 070-004	

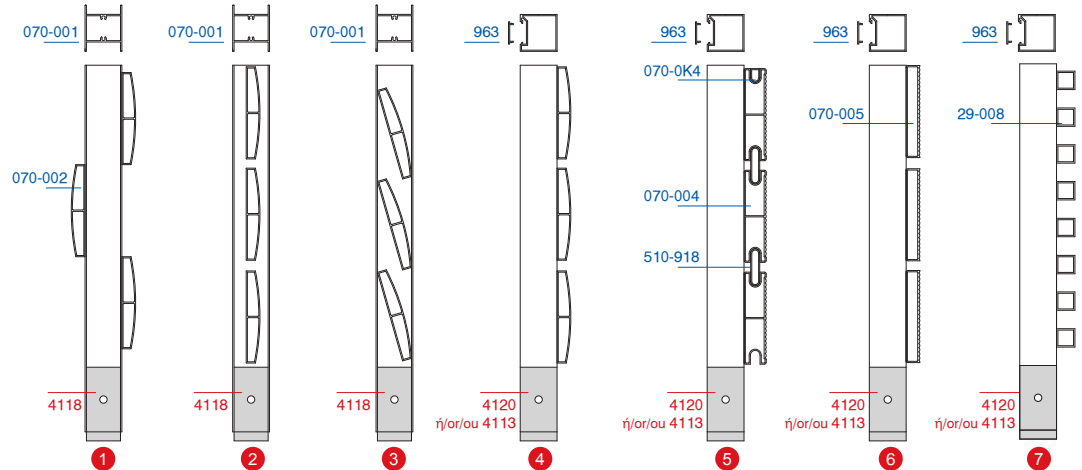
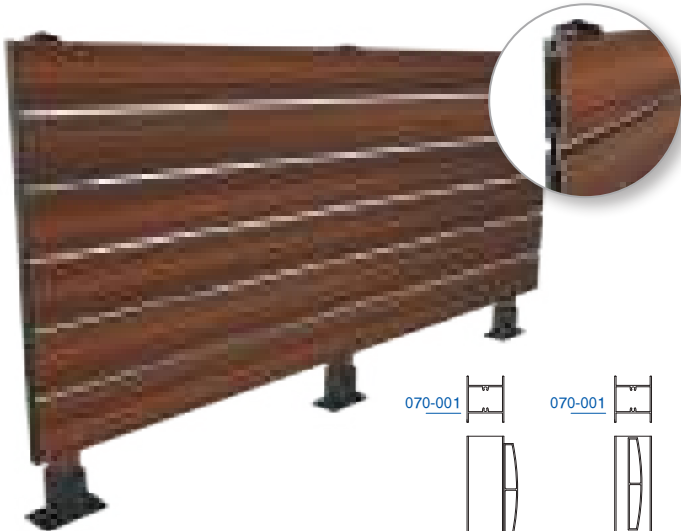

PERGOLAS

Lona

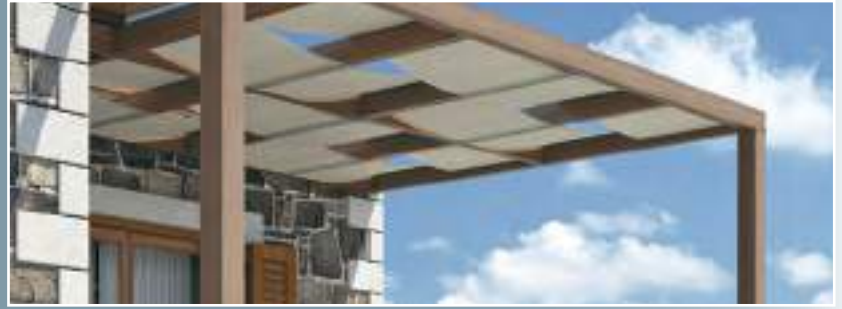
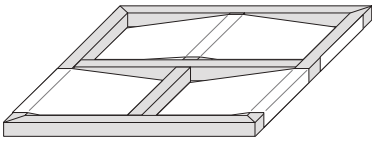

Alerones

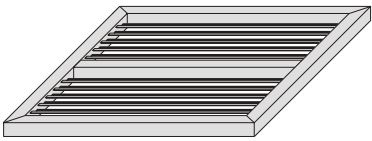

Lamas Fijas

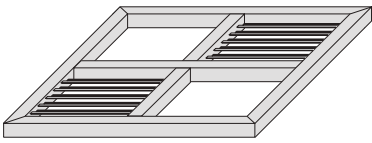

Clásico

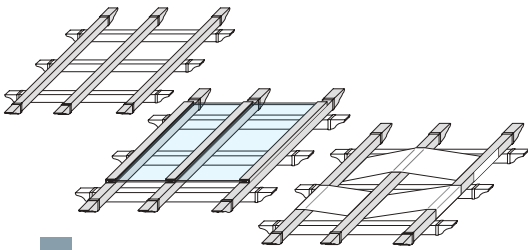

Moderno

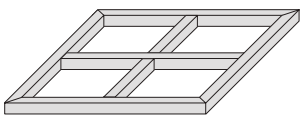

Con Cristal

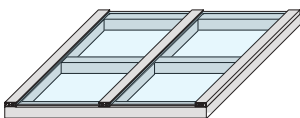

TECHADOS

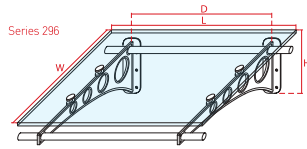
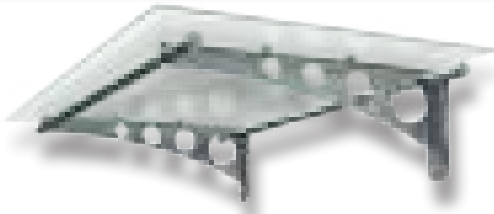

Code	L length mm	W width mm	H height mm	D distance mm
296-200	1400	1025	385	1280
296-201	1800	1025	385	1680
296-202	2200	1025	385	2080

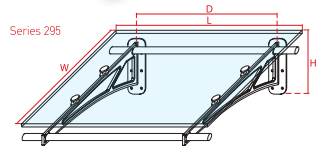

Code	L length mm	W width mm	H height mm	D distance mm
295-200	1400	1025	385	1280
295-201	1800	1025	385	1680
295-202	2200	1025	385	2080

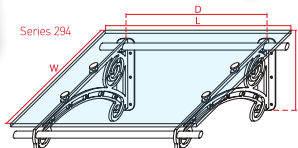
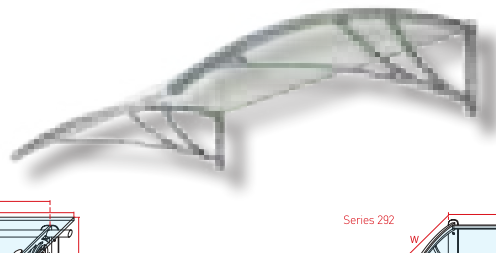

Code	L length mm	W width mm	H height mm	D distance mm
294-200	1400	1025	530	1280
294-201	1800	1025	530	1680
294-202	2200	1025	530	2080

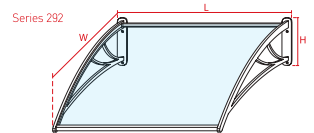

Code	L length mm	W width mm	H height mm
292-204	1400	1000	280
292-202	1200	1000	280
292-201	1000	1000	280

PERFILES Y ACCESORIOS PARA PERGOLAS

Cod. **900**

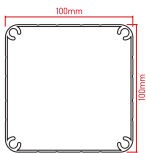

Columna de sujeción

Cod. **901**

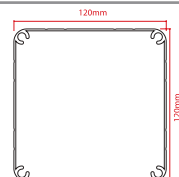

Columna de sujeción

Cod. **59-027**

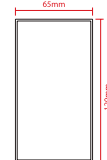

Perfil Travesaño

Cod. **59-028**

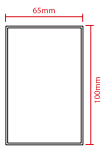

Perfil Travesaño

Cod. **59-026**

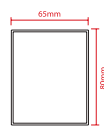

Perfil Travesaño

Cod. **272-211**

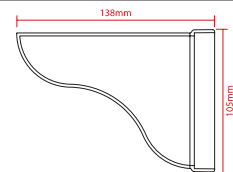

Acabado decorativo

Cod. **272-210**

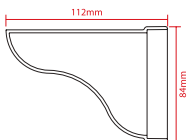

Acabado decorativo

Cod. **272-212**

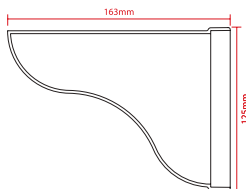

Acabado decorativo

Cod. **272-230**

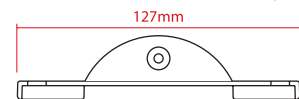

Tapa de la 901

Cod. **272-231**

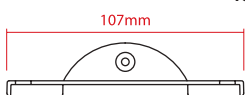

Tapa de la 900

Cod. **272-200**

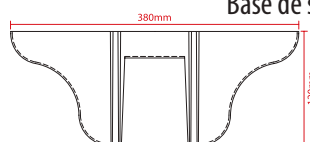

Base de sujeción

Cod. **29-047**



Perfil Standard

PERFILES Y ACCESORIOS PARA PERGOLAS

PERFILES PARA PERGOLA MODERNA

ACCESORIOS PARA PERGOLA MODERNA

Cod. **2050-601**

Mallorquina móvil

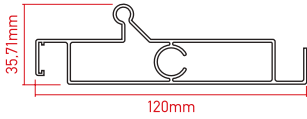

Cod. **2050-602**

Mallorquina fija

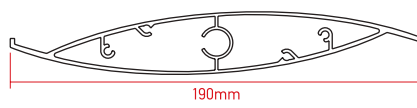

Cod. **2050-610**

Mallorquina fija

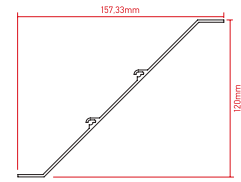

Cod. **970-401**

Travesaño

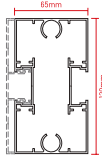

Cod. **970-402**

Travesaño

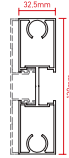

Cod. **970-901**

Base de mallorquina fija



Cod. **510-919**

Tapa de travesaño

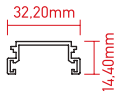

Cod. **510-920**

Tapa de travesaño

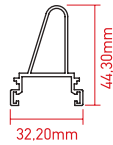

Cod. **970-902**

Perfil vierteaguas

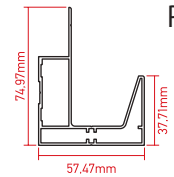

Cod. **2050-904**

Perfil para mover mallorquina



Cod. **2050-108**

Esquina columna

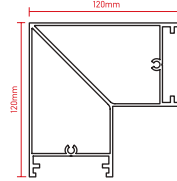

Cod. **2050-105**

Tapa columna 2050

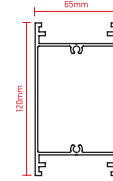

Cod. **2050-1K2**

Tapa columna de 2050-108 y 2050-105

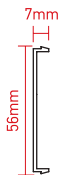

Cod. **970-903**

SUJECIÓN de travesaño regulable

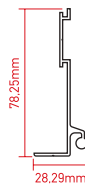

Cod. **970-904**

Base de sujeción del travesaño a pared

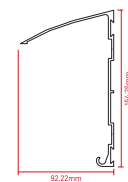

Cod. **410-903**

Perfil para sujeción de goma

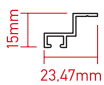

Cod. **272-242**

Pasador muelle



Cod. **272-243**

Pasador para mallorquina

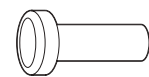

Cod. **272-244**

Eje plástico de mallorquina

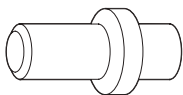

Cod. **272-245**

Eje plástico de mallorquina

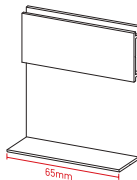

Cod. **E2050-012**

SUJECIÓN de esquina a columna

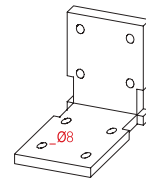

Cod. **E2050-022**

Unión columnas

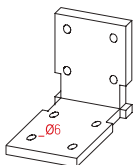

Cod. **272-300**

Motor eléctrico para pérgolas

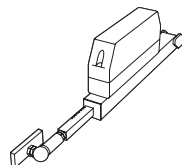

Cod. **272-301**

Mando a distancia para motor

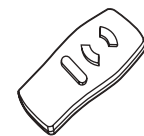

Cod. **970-1K1**

Tapa de unión 12-25mm

Cod. **970-1P2**

Placa de presión 12-25mm

Cod. **970-1B2**

Base de unión 12-25mm

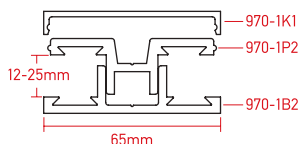

Cod. **970-1K1**

Tapa de unión 5-10mm

Cod. **970-1P1**

Placa de presión 5-10mm

Cod. **970-1B1**

Base de unión 5-10mm

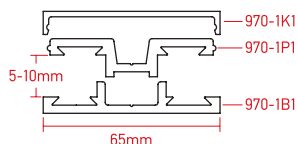

Cod. **970-1K5**

Tapa de unión 10-20mm

Cod. **970-1P2**

Placa de presión 10-20mm

Cod. **970-1B5**

Base de unión 10-20mm

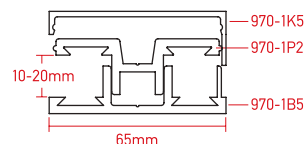

Cod. **948**

Tapa de unión para 12mm

Cod. **950**

Base de unión para 12mm

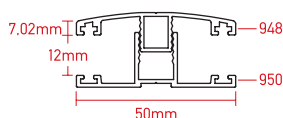

Cod. **949**

Tapa de unión para 20mm

Cod. **950**

Base de unión para 20mm

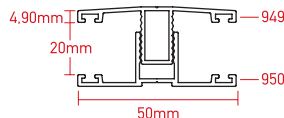

Cod. **272-400**

Goma para perfil 970-1P1 / 1P2 / 1B1 / 1B2 / 1B5

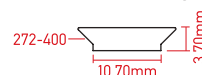

Cod. **410-406M**

Goma para perfil 948 / 949 / 950

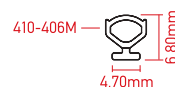

Cod. **970-F10**

Perfil en F para SUJECIÓN de policarbonato

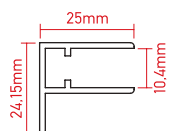

Cod. **970-F16**

Perfil en F para SUJECIÓN de policarbonato

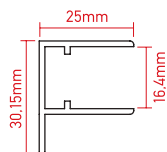

Cod. **970-F20**

Perfil en F para SUJECIÓN de policarbonato

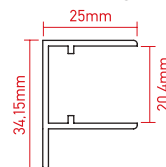

Cod. **272-213**

Tapa del perfil 59-028

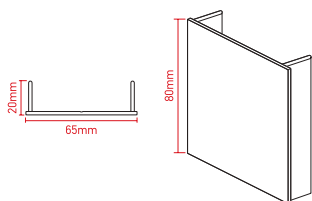

Cod. **272-214**

Tapa del perfil 59-027

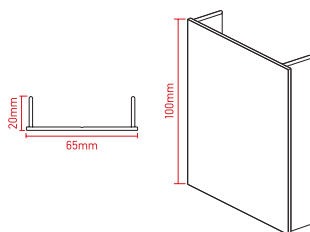

Cod. **272-215**

Tapa del perfil 59-026

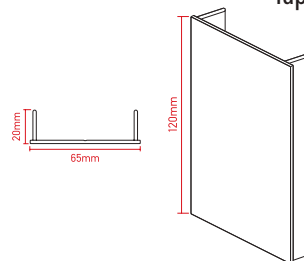

Cod. **272-240**

Base de SUJECIÓN tamaño 0 - 10°

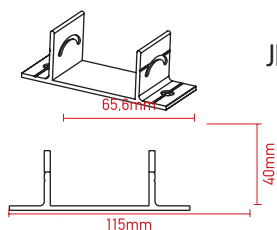

Cod. **272-241**

Base de SUJECIÓN tamaño 0 - 20°

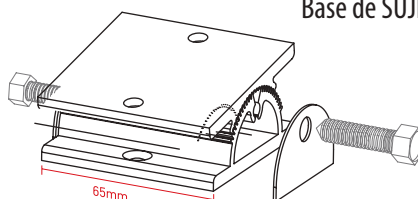

COLUMNAS DECORATIVAS

50. CAPITEL
(64,5x64,5x54cm)

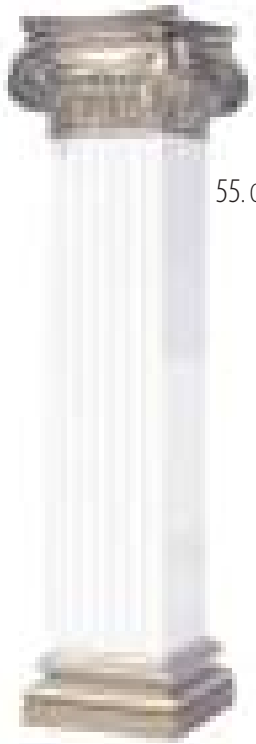

55. COLUMNA

140. CAPITEL
(44x44x20cm)

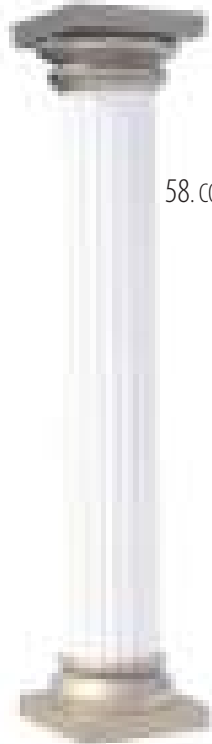

58. COLUMNA

60. CAPITEL
(45x45x40cm)

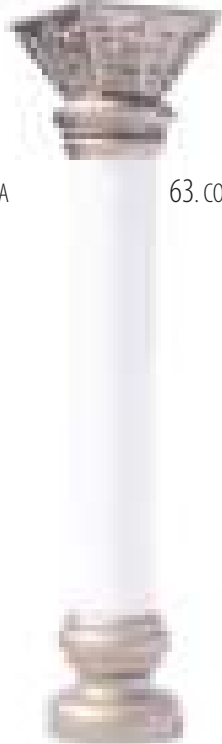

63. COLUMNA

65. CAPITEL
(24x25cm)



67. COLUMNA

69. ACABDO BASE COLUMNA
(16,5x15,5xcm)



70. COLUMNA

73. BOLICHE
(23x23cm)

76. COLUMNA FINAL
- 4 PERFILES COD.53
- 4 PERFILES COD.54



75 COLUMNA

74. BASE
(26x26cm)

75. COLUMNA
Union para vallas y balcones
(20x20x10cm)

51. BASE COLUMNA
(49x49x23cm)

56. BASE COLUMNA
(44x44x22cm)

61. BASE COLUMNA
(40x35cm)

66. BASE COLUMNA
(29,5x16cm)

71. BASE COLUMNA
(17x10cm)

52. IONIAN COLUMNA
montada a 100cm.

158. COLUMNA
montada a 100cm.

62. COLUMNA
montada a 100cm.

67. COLUMNA

70. COLUMNA

55. A CADA LADO DE LA COLUMNA
- 8 Perfiles Cod. 53
- 4 Perfiles Cod. 54



55. PERFIL COLUMNA



55. UNION DE PERFIL

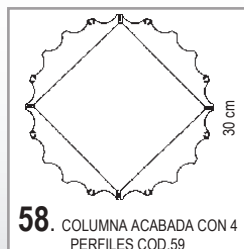

58. COLUMNA ACABADA CON 4 PERFILES COD.59

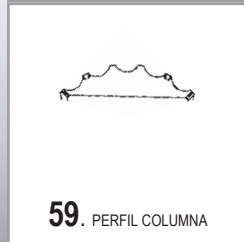

59. PERFIL COLUMNA



63. COLUMNA ACABADA CON 6 PERFILES COD.64

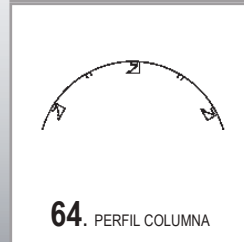

64. PERFIL COLUMNA

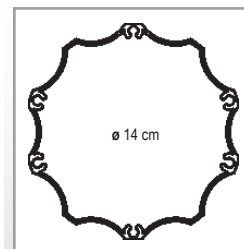

ø 14 cm

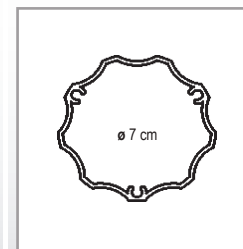

ø 7 cm

DECORACIÓN PORCHES



COD. 130 - CUCUNARA



COD. 131 - CUCUNARA



COD. 133 - RACIMO



COD. 132 - RACINO



COD. 135 - ROSETA



COD. 136 - ANGELITO



COD. 138 - MOSCOBITICO



COD. 137 - EROTAS



COD. 139 - (UNACARA) ARABIKO



FAROLAS DE ALUMINIO



330-4B	345-1B	275-1B	515-1P	345-3F	525-1P	375-4B	510-3F
PIRSOS Globo ø40		CRONOS Globo ø30	PIROFANI	CARAVOLO			
285-1F	345-2B	305-2B	515-2P	392-3F	525-2P	345-1F	480-3F
CRONOS Farol 5034		PIRSOS Farol 5034					
300-1F	315-2F	345-3B	305-3B	515-3P	392-4F	525-3P	510-4F

FAROLAS DE ALUMINIO



285-3F 285-4F 220-1F 230-1F 170-1F 260-3B 165-1B 340-3F

ZEUS Farol 5019



5002 5018 260-2B 265-2F 115-1F 280-3B 110-1B 340-4F

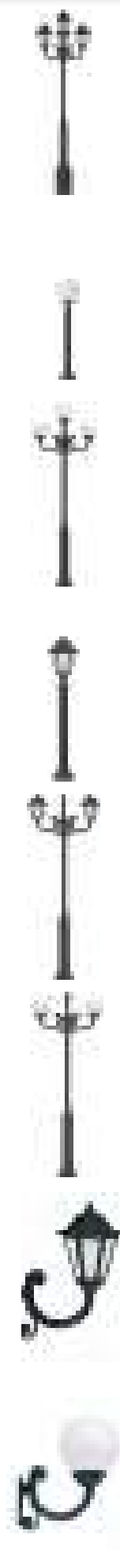

400-1F 215-1B 265-3F 5001 280-4B 250-2F 315-3F

REA Globo ø40

FOCO SUJETO AL SUELO

REA Farol 5019



MUEBLES DE JARDIN

6012



COMBINAR COD. 6023, 6024

6014



COMBINAR COD. 6025, 6026, 6027

6015



COMBINAR COD. 6025, 6026, 6027

6011



COMBINAR COD. 6023, 6024

6006



BASE MESA
COMBINAR COD. 6020

6010



COMBINAR COD. 6020, 6021

6008



COMBINAR COD. 6021, 6022, 6029

6007



TABLERO DE ALUMINIO (Incluido)Ø80

MUEBLES DE JARDIN

6032



SILLA CON BRAZOS

6003



SILLA SIN BRAZOS

6001



BANCO

6028



DOBLE BANCO

6033



BANCO METALICO TRIPLE

6034



BANCO METALICO

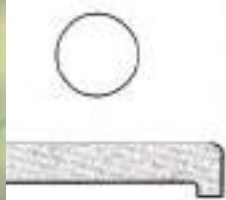

6020 Perimetro 60

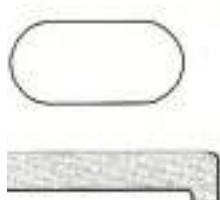

6021 Perimetro 80



6022 Perimetro 120



6023 (110 x 70cm)

6025 (165 x 95cm)

6029 Perimetro 105

6026 (165 x 95cm)

6024 (120 x 80cm)

6027 (185 x 100cm)



F 1000

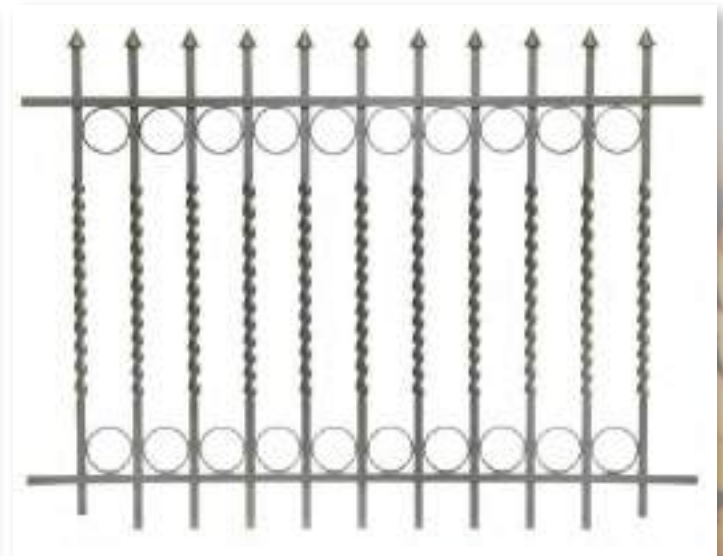

F 1001



F 1003

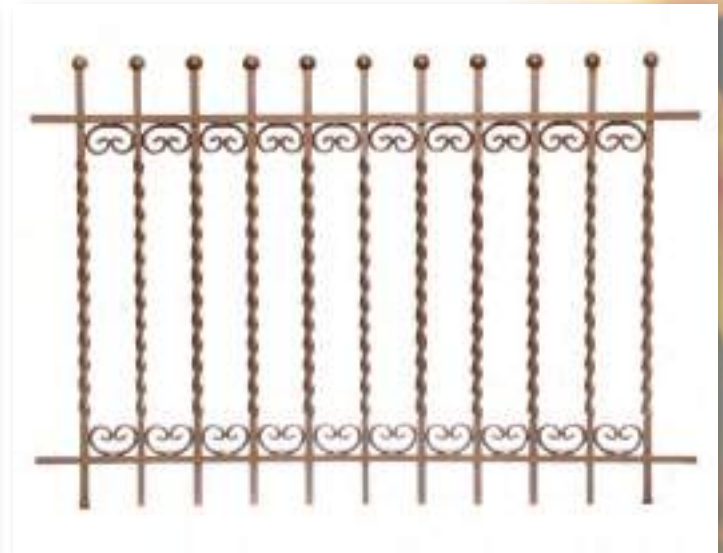

F 1004



cod.2011



cod.2010

Plantillas de sujeción al exterior del hueco

1.



194 - DEC. REJA



185 - DEC. REJA

2.



186 - DEC. REJA



187 - DEC. REJA

3.

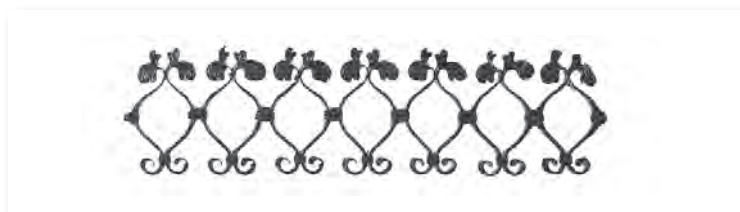

188 - DEC. REJA 96x19,5cm

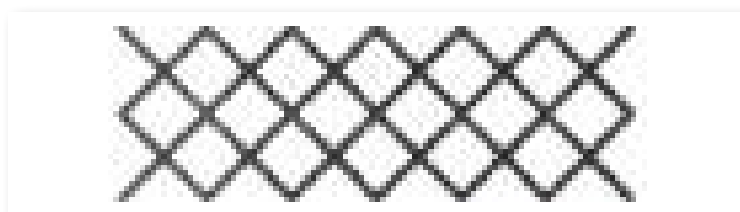

190 - DEC. REJA 96x25cm

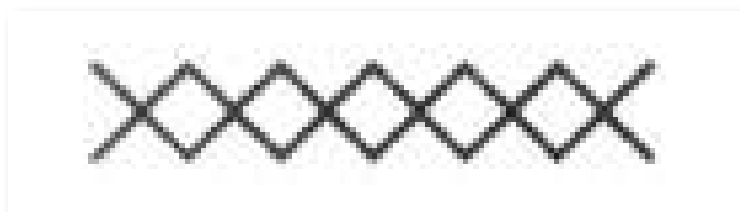

191 - DEC. REJA 96x13cm

PANEL Serie E 1000



1010



1011



1011



1015



1020



1031



1030



1035



1040



1050



1055



1060



1070



1071



1075



1080



PANEL Serie P 100



P102



P103



P112



P113



P142



P152



P143



P162



P132



P133



P190



P102K



P121



P106+101



P175+170



P125+120



PANEL Serie E 3000 Acorazadas



P3102



P3103



P3112



P3133



P3152



P3190



P3910



P3926



I 311 M



I 331 FU1



I 323 FU1



I 346 BR1



I 354 FU1



I 376 FU1



I 334 FU1



I 376 FU1



PANEL Serie SP 6000



SP6110



SP6120



SP6630+6130



SP6160



SP6170



SP6150



SP6690+6190



SP6740+6230

Accesorios



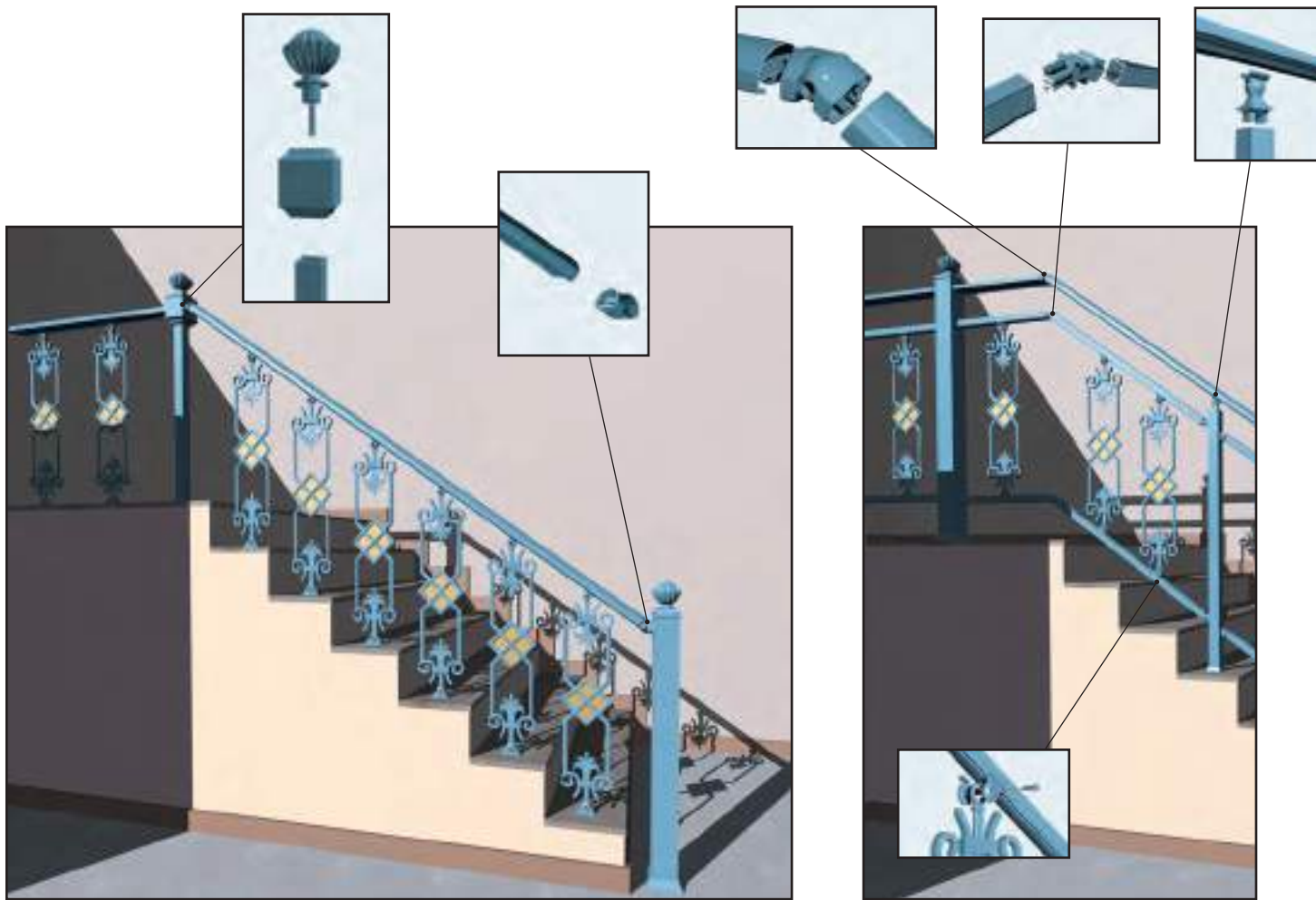

SISTEMA DE FIJACION AL SUELO



KIT DE MONTAJE PARA ESCALERAS



SISTEMA DOBLE RAIL

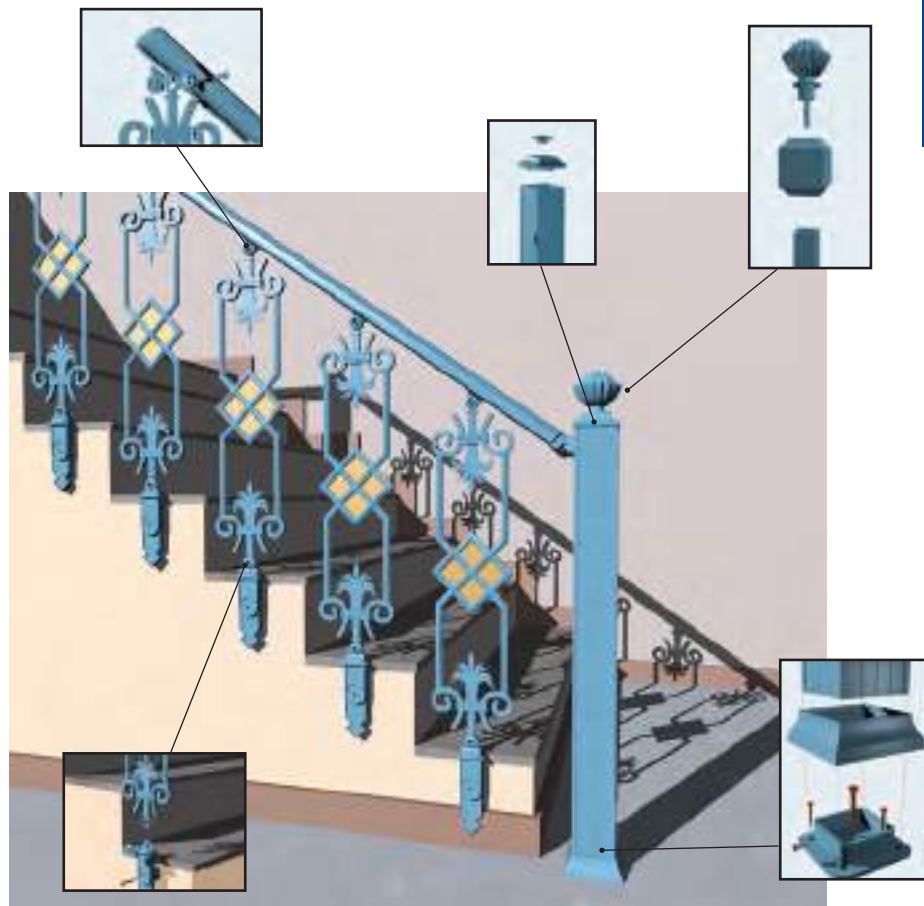

SISTEMA SOPORTE EXTERIOR

<p>CDD-4881 CUBO</p>	<p>CDD-4300 UNIÓN DE PASAMANOS EN ESCALERA PERPENDICULAR</p>	<p>CDD-4888 ACABADO PASAMANOS</p>	<p>CDD-4188 UNIÓN A PARED</p>	<p>SISTEMA DE SOLUCIÓN DE PASAMANOS CDD-4188</p>		
<p>CDD-4304 UNIÓN LATERAL PARA PASANOS</p>	<p>CDD-4308 UNIÓN DE RAIL A RAIL</p>	<p>CDD-4309 UNIÓN PASAMANOS COLUMNA</p>	<p>CDD-4488 SANA PARA COLUMNA CDD-35</p>	<p>CDD-4184 PIL BATERIA</p>	<p>CDD-407 UNIÓN AL PISO AL SUELO</p>	<p>CDD-4807 UNIÓN LATERAL DE COLUMNA-RAIL</p>



<p>cod 15 Pasamanos</p>	<p>cod 4201 Unión pasamanos columna</p>	<p>cod 4211 Unión columna con rail COLUMN</p>	<p>cod 4208 Unión módulo con columna</p>
<p>cod 915 Perfil 40x40</p>	<p>cod 4101 Nuevo pie de sujeción de columna 915</p>	<p>cod 4405 Tapa pasamanos</p>	<p>cod 4204 Unión intermedia para cod 16 y rail</p>



cod 4209
Unión sistema exterior



<p>cod 4303 Unión pasamanos regulable en esquina</p>	<p>cod 4412 Unión esquina para módulos exteriores</p>	<p>cod 875 Perfil esquina para módulo exterior</p>	<p>cod 30 Pasamanos</p>
<p>cod 4207 Unión esquina pasamanos cod 15 y 30</p>	<p>cod 4206 Unión pasamanos cod 15 y 30</p>	<p>cod 4502 Acabado pasamanos cod-15 y 30</p>	<p>La unión de pasamanos con columna de 40x40 se hace con tornillo</p> <p>cod 30 pasamanos con columna 915</p>













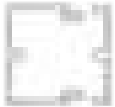









ACCESORIOS Y PERFILES

DISEÑO	CÓDIGO	DISEÑO	CÓDIGO	DISEÑO	CÓDIGO	DISEÑO	CÓDIGO
	4101		4154		4210		4401
	4102		4155		4211		4403
	4105		4162		4301		4405
	4106		4163		4302		4406
	4107		4202		4303		4408
	4109		4203		4304		4409
	4110		4204		4305		4410
	4113		4205		4306		4411
	4114		4206		4307		4412
	4151		4207		4308		4414
	4152		4208		4309		4416
	4153		4209		4311		4417

ACCESORIOS Y PERFILES

DISEÑO	CÓDIGO	DISEÑO	CÓDIGO	DISEÑO	CÓDIGO	DISEÑO	CÓDIGO
	4418		4605		37		135
	4420		4606		40		146
	4427		4607		43		147
	4501		4608		92		155
	4502		4609		93		159
	4503		4610		95		171
	4504		15		104		172
	4507		22		129		175
	4601		23		130		178
	4602		24		131		179
	4603		25		132		180
	4604		30		133		184

ACCESORIOS Y PERFILES

DISEÑO	CÓDIGO	DISEÑO	CÓDIGO
	185		830
	187		831
	188		832
	191		875
	202-401		882
	202-402		889
	820		890
	822		900
	823		901
	825		915
	828		921
	186		923



ALUMINCO con sede en Madrid, se fundó en el año 1999 y desde entonces hasta nuestros días hemos intentado llevar a nuestros clientes lo mejor de un producto que por sus características es muy especial e innovador.

Aluminio de alta calidad con diseños únicos y exclusivos que hacen de nuestra firma una de las más cualificadas del mercado nacional e internacional.

Barandillas, vallas, escaleras, puertas de jardín, puertas de panel, pérgolas, farolas, muebles de jardín...

Todo un mundo en aluminio..que te sorprenderá

www.aluminco.es

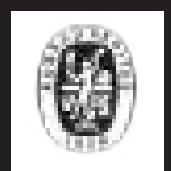



BALCONES • ESCALERAS • CANCELAS • VALLAS • DECORACIÓN DE JARDINES • PUERTAS DE PANEL



SISTEMAS DE ALUMINO CRISTALINE

**ALUMINCO & PANEL SL
C/ ARROYO DEL CULEBRO, S/N
POL. IND. LAS ARENAS DE PINTO
PINTO - MADRID C.P. 28320
(ESPAÑA)**

TELF.: +34 91 692 68 50 / FAX: +34 91 692 68 51

EMAIL: aluminco_panel@hotmail.com

WWW.ALUMINCO.ES

A L U M I N I U M S Y S T E M